



International Judo Federation

Official Partner of the 2021-2024 Sports
Season - International Judo Federation (IJF)

M. Sebastien Abrantes

+33 (0)7 83 94 43 19

contact@impulsefitness.fr
International Fitness Equipement SAS





Your Wellness Solution Provider



INTRODUCTION

In the early 1990s, Impulse began the production of fitness equipment. After nearly 30 years of experience accumulation, Impulse (Qingdao) Health Tech Co., Ltd. was established in 2004, focusing on the research, development, manufacturing and sales of fitness equipment. In September 2017, Impulse did IPO successfully in Shenzhen stock market. It achieved breakthrough in capital market and brought more financial support to R&D and manufacture of Impulse.

Our products cover both business and home user core demand. We provide innovative and high-quality indoor and outdoor products, including cardio equipment, strength equipment, functional training and rehabilitation training equipments, also with intelligent and innovative home use products. The forward-looking design concept and user demand focused are the features of Impulse product development. We are committed to providing the desired products and services at a sincere price, and the products have been sold across more than 200 countries and regions, and created global marketing and after-sale systems.

Impulse is a leading supplier in health industry. A perfect product and service system has been built in the fields of fitness equipment R&D, manufacturing, marketing and sales, club operation and health management. The Impulse new industrial park is under construction, the first phase of the project has a total investment of \$232 million USD and a total construction area of 168,995.98 square meters. It is expected that the annual output value of the project can be \$620 million USD after the project reaches full capacity.

We believe that the trust of customers comes from our pursuit of product excellence and exploration of customer needs. Therefore, Impulse is going to continue following the concept of customer first and quality priority in order to serve our business partners, and become reliable fitness expert trusted by global customers.



CARDIO

TREADMILL	RT970	3
	RT750 RT700	5
	AC4050	7
	AC4000 AC4015	9
	AC8	11
	PT300	13
	AC2990	15
	FGT300	17
STAIR	XSC750 XSC700	21
UPRIGHT BIKE	RU970	25
	RU700 RU500	27
	ECU7	29
	GU500	31
RECUMBENT BIKE	RR970	35
	RR700 RR500	37
	ERU7	39
	GR500	41
ELLIPTICAL	RE970	45
	RE700 RE500	47
	FGE300	49
SPIN BIKE	PS460	53
	PS450 PS300	55
HIIT	HSR007	59
	HSR005	63
	HB005	65
	HC005	67

STRENGTH

SELETORIZED	EXOFORM	69
	SL95	83
	IT95	91
	IF93	107
JUNGLE	PL	117
	IT95	121
	SL95	129
PLATE LOADED & FREE WEIGNT	IF93	131
	ECP	133
	SL70	141
	IFP	159
MULTI GYMS & DAP	IT7	171
	IF	181
	ES	195
	IF HOME GYM	203
AIR RESISTANCE	IFCC	205
	IFFT	206
	IF2001	206
HYDRAULIC	HSP-PRO	207
	RL	209
RACKS & RIGS & PLATFORM	MS	213
	FF	219
	HSP-PRO	223
	ZONE	225

TREADMILL

in impulse



RT970 TREADMILL



Model	RT970
Certification	CE,ETL,EN957
Max User Weight	180kg/396lbs
AC/DC	AC
Power Requirement	15A
Electrical Receptacle & Plug	220-240V
Motor Power	4HP
Motor Peak Power	6HP
Speed range	1-25km/h (1-15mph)
Incline range	0-15%
One Touch Buttons	3%,6%,9%,12%(Incline);3,6,9,12(Speed)
Handle bar Control	Yes
Console Display	21.5" TFT
Console Readouts	Heart rate, %Heart rate, Time in zone, Average Speed, Pace, Time Elapsed, %Time Remaining, Calories, Calories/Hour, Distance, Steps, Speed, Incline
Language	EN/CN/FR/DE/ES/PT/IT/RU/JP/KR
Metric/English	Metric/English
Touch Screen	Yes
Entertainment	Multiple built-in apps
Programs	Cardio, Random, Fatburn, Hills, Interval, HR, Fit test
HR Monitor	Contact&Telemetry
Roller Diameter	Front:88.9mm/3.5" Back:76mm/3"
Deck	Reversible 1" Deck
Running surface	558×1524(mm)/22"×60"
Belt Thickness	1.6mm
Belt Brand	Habasit
Step-up Height	245mm™
Suspension System	Pulflex Commercial Suspension System
Accessory Storage	IPAD/Phone Holder/Magazine Holder/2 Bottle Holders
Charging Unit	Wireless
USB Data Exchange	Yes
Fan	Yes (3 speed level)
Multi-language Display	Yes
Gross Weight	266.8kg/588.2lbs
Net Weight	203kg/447.5lbs
Product Dimension	2078×950×1569(mm)/ 81.8"×37.4"×61.8"



RT750
TREADMILLRT700
TREADMILL

Model	RT750	RT700
Certification	CE,ETL,EN957	CE,ETL,EN957
Max User Weight	180kg/396lbs	180kg/396lbs
AC/DC	AC	AC
Power Requirement	15A	15A
Electrical Receptacle & Plug	220-240V	220-240V
Motor Power	4HP	4HP
Motor Peak Power	6HP	6HP
Speed range	0.6-25km/h (0.6-15mph)	0.6-25km/h (0.6-15mph)
Incline range	0-15%	0-15%
One Touch Buttons	3%,6%,9%,12%(Incline); 3,6,9,12(Speed)	2%,5%,8%,(Incline);3,6,9(Speed)
Handle bar Control	Yes	Yes
Console Display	7 LED + Matrix 16×32	7 LED + Matrix 16×40
Console Readouts	Heart rate, %Heart rate, Time in zone, Average Speed, Pace, Time Elapsed, %Time Remaining, Calories, Calories/Hour, Distance, Steps, Speed, Incline	Heart rate, Time Elapsed, Calories, Distance, Speed, incline, 1/4 mile or 400 meters motivational track
Metric/English	Metric/English	Metric/English
Programs	Manual, Cardio, Interval Burn, Calories Heart Rate, Advanced	Manual, Cardio, Interval Burn, Calories Heart Rate, Advanced
HR Monitor	Contact&Telemetry	Contact&Telemetry
Roller Diameter	Front:88.9mm/3.5" Back:76mm/3"	Front:88.9mm/3.5" Back:76mm/3"
Deck	Reversible 1"Deck	Reversible 1"Deck
Running surface	558×1524(mm)/22"×60"	558×1524(mm)/22"×60"
Belt Thickness	1.6mm	1.6mm
Belt Brand	Habasit	Habasit
Step-up Height	245mm	245mm
Suspension System	Pulflex™ Commercial Suspension System	Pulflex™ Commercial Suspension System
Accessory Storage	IPAD/Phone Holder/Magazine Holder/2 Bottle Holders	IPAD/Phone Holder/Magazine Holder/2 Bottle Holders
USB Charger	Yes	No
Fan	Yes (3 speed level)	Yes (3 speed level)
Multi-language Display	Yes	No
Gross Weight	Box1: 232.2kg/510.8lbs Box2: 41.5kg/91.3lbs	Box1: 238.0kg/523.6lbs Box2: 35.0kg/77.0lbs
Net Weight	Box1: 176.7kg/388.7lbs Box2: 30.5kg/67.1lbs"	Box1: 179.1kg/394.0lbs Box2: 27.5kg/60.5lbs
Product Dimension	2078×950×1590(mm)/ 81.8"×37.4"×62.6"	2078×875×1513(mm)/ 81.8"×34.4"×59.6"
Packing size	Box 1: 2230×970×480(mm)/87.8"×38.2"×18.9" Box 2: 1145×1105×390(mm)/45.1"×43.5"×15.4"	Box 1: 2230×970×480(mm)/ 87.8"×38.2"×18.9" Box 2: 975×965×280(mm)/ 38.4"×38.0"×11.0"
40HQ	/	51Sets
40GP	40Sets	42Sets





AC4050
TREADMILL

Model	AC4050
Certification	CE
Max User Weight	150kg/330lbs
AC/DC	AC
Power Requirement	15A
Electrical Receptacle & Plug	220-240V
Motor Power	3HP
Speed range	1-22km/h
Incline range	0 to 15%
One Touch Buttons	3%,6%,9%(Incline);3,6,9(Speed)
Console Display	21.5" Touch Screen
Language	EN/CN/FR/DE/ES/PT/IT/RU/JP/KR
HR Monitor	Contact&Telemetry
Roller Diameter	Front:88.9mm/3.5" Back:76mm/3"
Deck	Reversable 1"Deck
Running surface	545×1524(mm) / 21.5"× 60"
Belt Thickness	2.3mm
Step-up Height	260mm
Suspension System	Pulflex Commercial Suspension System
Accessory Storage	IPAD/Phone Holder/Magazine Holder/ 2 Bottle Holders
Charging Unit	Wireless
Fan	Yes (3 speed level)
Product Dimension	2102×950×1593(mm) 82.7"×37.4"×62.7"
Packing size	Box 1: 2260×930×490(mm) 89.0"×36.6"×19.3" Box 2: 1145×1095×380(mm) 45.1"×43.1"×15.0"
40HQ	44Sets
40GP	40Sets





AC4000
TREADMILL



Multiple incline and speed quick adjustment keys for convenient and swift operation.



AC4015
TREADMILL



The 18.5-inch large console created by the new design language features convenient operation and entertainment functions. The 60 degrees tilted panel provides the best viewing Angle and comfortable experience. (AC4000)



50x185x2.5mm oversized column is adopted to ensure the stability of the console during movement, when the speed reaches 20km/h, the vibration amplitude of the motor is less than 0.003mm.



The motor cover adopts a flat design to make it more integrated with the frame of the running platform and more concise and hardcore in appearance. On this basis, the column cover is added and the lower end of the column is wrapped in the motor cover to make the column and running platform perfectly integrated.



Considering the safety of the product, the manufacturing process of the edge strip is upgraded from PVC extrusion to ABS injection molding, which increased the friction coefficient and enhanced the anti-slip performance.

Model	AC4000/4015
Certification	CE
Max User Weight	150kg/330lbs
AC/DC	AC
Power Requirement	15A
Electrical Receptacle & Plug	220-240V
Motor Power	3HP
Speed range	1-22km/h
Incline range	0 to 15%
One Touch Buttons	3%,6%,9%(Incline);3,6,9(Speed)
Console Display	LED
Console Readouts	Time, Avg Speed, Heart Rate, Distance, Steps, Calories, Cal/Hour, Speed, Incline, 1/4 mile or 400 meters motivational track
Metric/English	Metric&English
Programs	Manual, Cardio, Heart Rate, Interval, Burn Calories, Target
HR Monitor	Contact&Telemetry
Roller Diameter	Front:88.9mm/3.5" Back:76mm/3"
Deck	Reversable 1"Deck
Running surface	545×1524(mm) / 21.5"×60"
Belt Thickness	2.3mm
Step-up Height	260mm
Suspension System	Pulflex Commercial Suspension System
Accessory Storage	IPAD/Phone Holder/Magazine Holder/ 2 Bottle Holders
USB Charger	Yes
Fan	Yes (3 speed level)
Gross Weight	Box1: 231kg/508.2lbs Box2: 35.8kg/78.8lbs
Net Weight	Box1: 173kg/380.6lbs Box2: 30kg/66lbs
Product Dimension	2102×950×1592(mm) 81.7"×37.4"×62.6"
Packing size	Box 1: 2230×970×480(mm) 87.8"×38.2"×18.9" Box 2: 1145×1105×390(mm) 45"×43.5"×15.4"
40HQ	44Sets
40GP	40Sets

AC850 TREADMILL



The AC850 is available with the All-new Touchscreen System



Integral foam handlebars provide a better user experience and safety protection.

Rubber spring cushioning system offers superior shock absorption, promoting joint protection for lower limbs. With a two-stage buffering structure, it automatically adjusts to users of different weights, providing enhanced joint protection.



Phenolic resin coating on the treadmill belt provides durability, self-lubrication, and extended lifespan.



Designed with incline settings ranging from 0 to 20%, offering users a broader range of incline training options.



Symmetrical inward sloping design of the foot pedal edges ensures reliable safety protection for users.



Equipped with Bluetooth module for connectivity to apps like Zwift, enabling training and data collection.



Wireless charging for mobile phones adds extra value and convenience beyond the product's primary function.

AC810 TREADMILL



AC800 TREADMILL

Model	AC850/AC810/AC800
Power Requirement	16A
Electrical Receptacle & Plug	220-240V AC
AC/DC	AC
Motor Power	3HP
Max User Weight	150KG/330lbs
Speed Range	0-20KM/H
Incline Range	0-20%
Step-up Height	276MM
Deck	25.4MM
Running Surface	560×1550mm/ 22.0"×61.0"
Belt Thickness	2.3mm
Suspension System	Two-stage Buffering
Accessory Storage	Ipad/Iphone Holder/Magazine Holder/ 2 Bottle Holders
Console Display	21.5" TFT (AC850 Only)/6LED+DOT MATRIX
HR Monitor	Contact & Telemetry
Console Readouts	Speed, Incline, Distance, Time, HR, Calories
Fan	Yes
Wireless Charging	Yes (AC850/810 Only)
Filter	Yes (AC850/810 Only)
Bluetooth	Yes (AC850/810 Only)
Product Dimension	2126×933×1598mm/ 85.0"×36.7"×62.9"
40HQ	44
40GP	40



PT300
TREADMILL

Model	PT300
Certification	CE,ETL,EN957
Max User Weight	150kg/330lbs
AC/DC	AC
Power Requirement	15A
Electrical Receptacle & Plug	220-240V
Motor Power	3HP
Motor Peak Power	4.5HP
Speed range	0.6-20km/h (0.6-12mph)
Incline range	0-15%
One Touch Buttons	2%,4%,6%,8%,10%,12%(incline), 2,4,6,8,10,12(Speed)
Console Display	6 LED + Matrix 16×40
Console Readouts	Heart rate, Time Elapsed, Calories, Distance, Speed, incline, 1/4 mile or 400 meters motivational track
Metric/English	Metric&English
Programs	5 Preset, 3 Targets, 2 User, 3 HR
HR Monitor	Contact&Telemetry
Roller Diameter	Front:88.9mm/3.5" Back:76mm/3"
Deck	Reversible 1"deck
Running surface	545×1524(mm) / 21.5"×60"
Belt Thickness	2.3mm
Step-up Height	260mm
Suspension System	Pulflex™ Commercial Suspension System
Accessory Storage	Phone Holder/ 2 Bottle Holders
Fan	Yes (3 speed level)
Gross Weight	Box1: 223.8kg/492.4lbs Box2: 39.5kg/86.9lbs
Net Weight	Box1: 180.2kg/396.4lbs Box2: 30.9kg/68.0lbs
Product Dimension	2136×934×1464(mm)/84.1"×36.8"×57.6"
Packing Size	Box 1: 2260×930×550(mm)/89.0"×36.6"×21.7" Box 2: 1265×1050×350(mm)/49.8"×41.3"×13.8"
40HQ	41Sets
40GP	36Sets



AC2990 TREADMILL



The 3D fixed upright can easily eliminate the abnormal sound and console shaking along with the running. At the same time, move the upright to the front can create a wide running environment and eliminate visual obstacles.



Taking full consideration of the commercial long running situation, the dustproof heat dissipation holes are designed in the console and the motor cover to dissipate heat from the electrical part and prevent the aging problem.

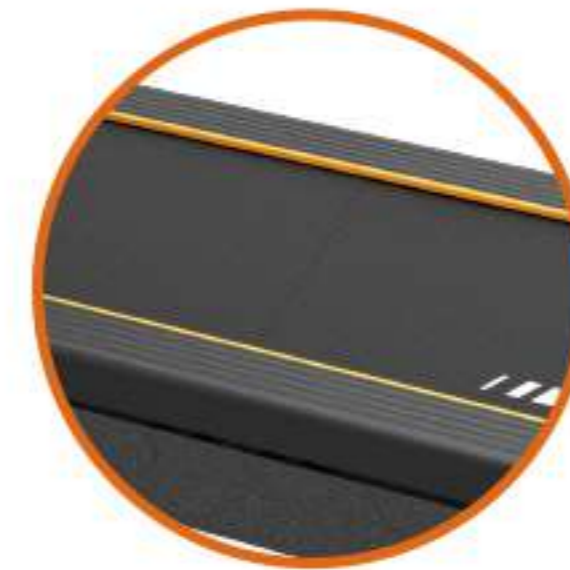

The platform structure was upgraded on the basis of AC2970 to improve the stability and safety. The replacement of a more advanced console surface material is all about enhancing the product's durability.



Ergonomic handle design; more quick buttons and a larger phone/tablet holder for a more comfortable user experience.

Model	AC2990
Max User Weight	150kg/330lbs
AC/DC	AC
Power Requirement	15A
Electrical Receptacle & Plug	220-240V
Motor Power	3HP
Motor Peak Power	4.5HP
Speed range	1-20km/h
Incline range	0 to 15%
One Touch Buttons	2%,4%,6%,8%,10%,12%(Incline);2,4,6,8,10,12(Speed)
Console Display	6 LED + Matrix 8×16
Console Readouts	Time, Avg Speed, Heart Rate, Distance, Steps, Calories, Cal/Hour, Speed, Incline.
Metric/English	Metric&English
Programs	Manual mode; Target mode: time, distance and calories; Standard mode: P1-P5; User mode: U1 and U2; Heart rate mode: HR1, HR2, HR3
HR Monitor	Contact
Roller Diameter	Front:76.5mm/3" Back:76.5mm/3"
Deck	Reversible 1"Deck
Running surface	560×1524(mm)/ 22.0"×60.0"
Belt Thickness	2.3mm
Step-up Height	250mm
Suspension System	Pulflex Commercial Suspension System
Accessory Storage	Phone Holder/ 2 Bottle Holders
Gross Weight	239.7kg/527.3lbs
Net Weight	170.3kg/374.7lbs
Product Dimension	2206×923×1579(mm) 86.9"×36.3"×62.2"
Packing Size	BOX1:2320×955×530(mm) 91.3"×37.6"×20.9" BOX2:1025×1015×360 40.3"×40.0"×14.1"
40HQ	44
40GP	37

* The right of specific weight to actual supply prevail.

FGT300 TREADMILL



Power-off State

Concealed Capacitive Touch LED Mirror Screen
Featuring a concealed capacitive touch button design for responsive and pressure-free interactions, enhancing product longevity. The screen, in its powered-off state, seamlessly blends into a unified black mirror surface, elevating the overall aesthetic appeal.

15W Wireless Charging



Smart Knob
Press to start, rotate left for deceleration/right for acceleration, short press to pause, long press to stop. Additionally, quick adjustments can be made during parameter settings.



Bottom-mounted Motor Design

Utilizing a bottom-mounted motor design, the running belt seamlessly extends across the entire deck, significantly enhancing belt utilization. This innovative approach increases the running space by 20%, providing an expansive 520mm × 1700mm area for an unobstructed and enjoyable running experience.

Model	FGT300
Max User Weight	150kg
Power Requirement	220V/10A
Motor Power	2.5HP
Motor Peak Power	5.0HP
Speed Range	0.5-18km/h
Incline Range	0-15% (15 levels)
Suspension System	10-Point Full Deck Suspension System
Console	5 LED windows +16×32 Matrix
Console Readouts	Speed, Incline, Time, Distance, Calories, HR
HR Monitor	Contact
Quick Button	8 Direct Speed Selection Buttons
Preset Program	24
Target Program	3
Custom Program	3
Fit Test Program	1
Charging Unit	Wireless
Accessory Storage	Pad Phone Holder/Bottle Holder
Product Dimension	1856×811×1546mm/73.1×31.9×60.9(in)
Packing Dimension	2230×910×450mm/87.8×35.8×17.7(in)
Running Surface	520×1700mm/20.5×66.9(in)
Net Weight	115kg/253.5lbs
Gross Weight	133kg/293.2lbs
Deck Thickness	20mm
Belt Thickness	1.8mm



STAIR

XSC750 STAIR CLIMBER



The ergonomic design of quick adjustment knob increases the convenience and comfort of adjustment while training.



The central control handle is equipped with a hand-held HRM, speed adjustment buttons on the right side, and an emergency stop button on the left side, allowing you to control the speed and your safety at any time.



The extended armrest with TPU coating can enhance the user's comfort.



Ergonomic design of 202mm step-up height.



Equipped with infrared sensor switch to provide double protection.

Automatic brake function when power is off to ensure safety.

The chain gear adopts the expansion sleeve, which is convenient for installation, adjustment and maintenance.



The PP material pedals to reduce the noise during use.

Adopt chain and wedge-shaped belt combined transmission to reduce noise and keep transmission power not attenuated.

The two-stage transmission realizes a wide range of step adjustment.

The magnetic resistance part is placed on the side for easy maintenance.



Equipped with moving wheel, convenient for moving.



The foot pedals on both sides, which is easy to use.

Model	XSC750/700
Certification	CE
Maximum User Weight	160kg/352lbs
Power Requirement	10A
Electrical Receptacle & Plug	100-240V
Resistance System	Plug-in Magnetic Resistance
Resistance Brake Power	700w
Resistance Levels	20
Speed Range	25-158steps/min
Step Length	559mm/22.0"
Step Width	254mm/10"
Step Height	202mm/8.0"
Heart Rate Monitor	Contact&Telemetry
Console Display	Touch Screen/LED + Dot Matrix
Console Readouts	Time,Steps,Calories,Speed, Heart Rate,Gear Level
Default Programs	Quick Start,Climbing 1-5,Interval 1-5
Target Programs	Time,Distance,Calories
HRC Programs	Target HR,Interval HR
Custom Programs	Custom Distance,Custom Climbing, Custom Interval
Touch Screen	Optional
Charging Unit	Wireless
Packing form	Wooden Box
Accessory Storage	Cup Holder, Magazine Holder, Phone Holder
Product Dimension	1421×928×2248(mm) 55.9"×36.5"×88.5"
Product Weight	206.4kg/455.0lbs
40GP Container Count	16



The touchscreen console is optional.



XSC700 STAIR CLIMBER



UPRIGHT BIKE

RU970 UPRIGHT BIKE

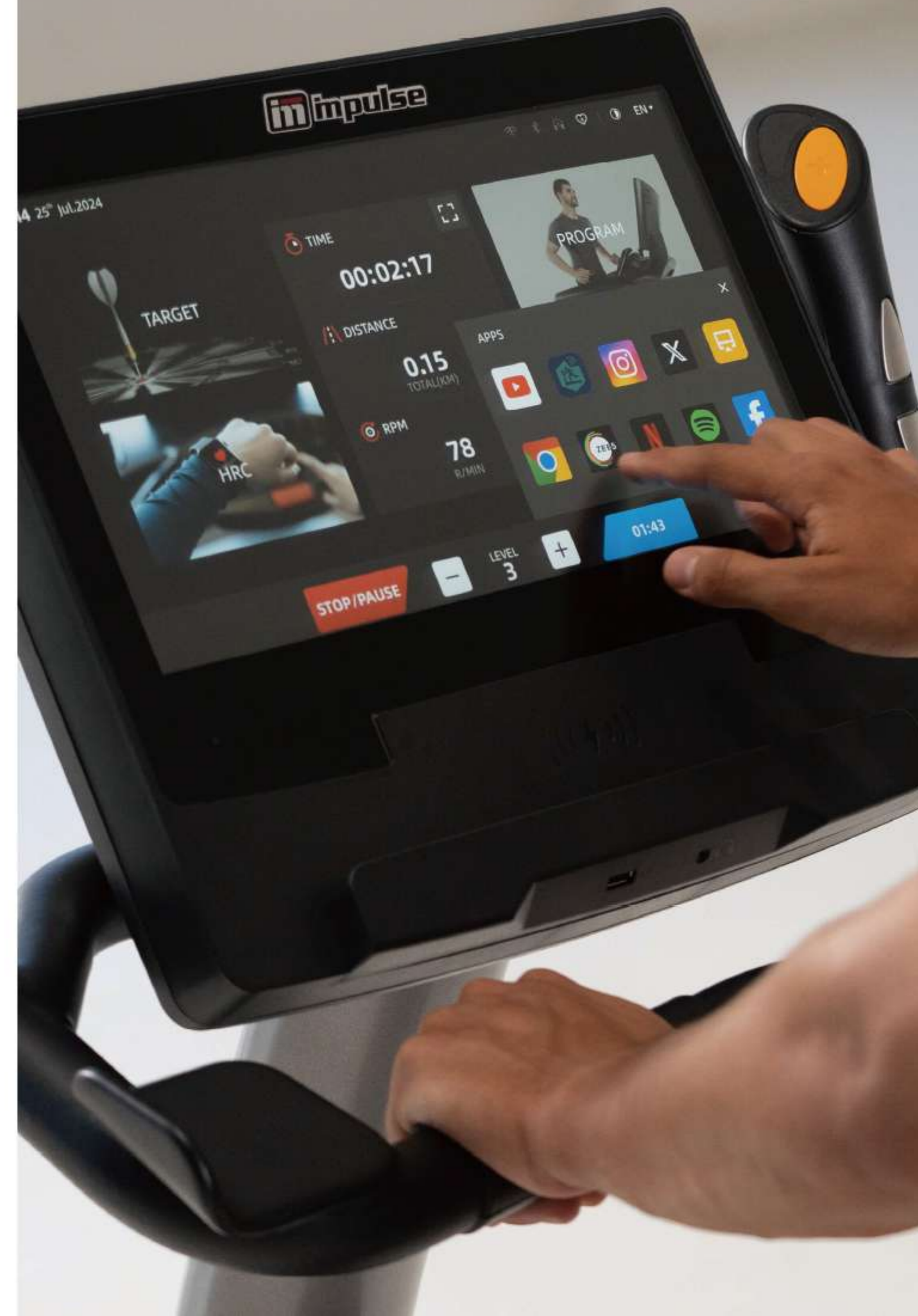

Model	RU970
Certification	CE
Max User Weight	180kg/396lbs
Electrical Receptacle & Plug	220V-240V
Brake Type	Self powered hybrid brake
Resistance Brake Power	450W
Resistance Levels	25
Crank	Oversized
Pedal	Oversize dual-sided pedals with integrated straps
Flywheel Weight	9kg
Handle bar Control	3 riding positions, with contact heart rate grips and on-your-finger-tips control
Console Display	15.6" TFT
Console Readouts	Resistance, time, distance, calories, HR, RPM
Language	EN/CN/FR/DE/ES/PT/IT/RU/JP/KR
Metric/English	Metric&English
Entertainment	Multiple built-in apps
Programs	5
HR Monitor	Contact&Telemetry
Accessory Storage	Yes
Charging Unit	Wireless
USB Data Exchange	Yes
Multi-language Display	Yes
Gross Weight	87.8kg/193.6lbs
Net Weight	67.5kg/148.8lbs
Product Dimension	597 × 1092 × 1505(mm) 23.5" × 43.0" × 59.3"



RU700
UPRIGHT BIKE



RU500
UPRIGHT BIKE

Model	RU700	RU500
Certification	ETL/CE/EN957	ETL/CE/EN957
Max User Weight	180kg/396lbs	160kg/352lbs
Electrical Receptacle & Plug	No	No
Brake Type	Self Powered Hybrid Brake	Self Powered Hybrid Brake
Resistance Brake Power	300W	300W
Resistance Levels	25	20
Crank	Oversized	Standard
Pedal	Oversize dual-sided pedals with integrated straps	Single sided weighted pedal
Flywheel Weight	9kg	8kg
Handle bar Control	3 riding positions, with contact heart rate grips and on-your-finger-tips control	3 riding positions, with contact heart rate grips
Console Display	6 Windows+Dot Matrix	7Windows+Dot Matrix
Console Readouts	Distance, time, speed, watt, calories, heart rate	Distance, time, speed, watt, calories, RPM, heart rate
Metric/English	Metric&English	Metric&English
Programs	7	11
HR Monitor	Contact&Telemetry(polar)	Contact&Telemetry
Accessory Storage	Yes	Yes
Special Features	On-your-finger-tips, Ergonomically designed handle bars, Two-sided pedals, K-O-P-S biomechanics, Easy to service	On-your-finger-tips, Ergonomically designed handle bars, Two-sided pedals, K-O-P-S biomechanics, Easy to service
Gross Weight	84.8kg/186.6lbs	81.0kg/178.2lbs
Net Weight	67.0kg/147.4lbs	68.0kg/149.6lbs
Product Dimension	1093×602×1493(mm)/ 43.0"×23.7"×58.8"	1093×660×1492(mm)/ 43.0"×26.0"×58.7"
Packing Size	1160x405×870(mm)/ 45.7"×15.9"×34.3"	1160×405×870(mm)/ 45.7"×15.9"×34.3"
40HQ	172Sets	172Sets

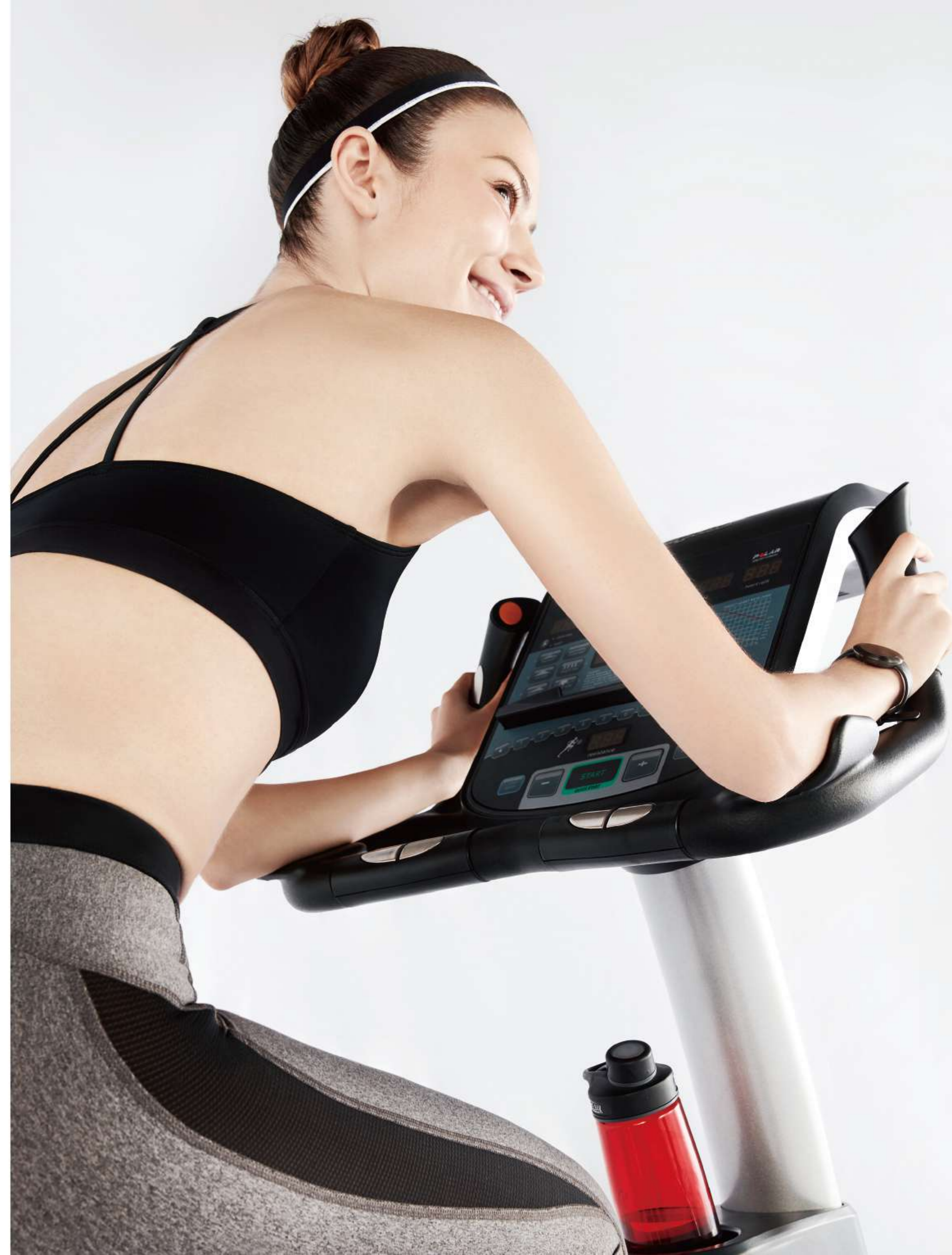

ECU7
UPRIGHT BIKE



User-friendly console with keypad and scrolling LED window, multiple workout programs and unique heart rate zone programs.



Multiple riding grip positions are fitted with two sets of heart-rate reception, which provides users different workout experience. Bright colored fingertip controls for changing resistance for easy adjustments throughout the workout.



Dual oversized water bottle holders and mobile phone pocket conveniently located for those long bike rides.



Ergonomic single-hand seat adjustment makes easy to find the right position.



Easy to service shroud design allows for convenient maintenance.



Model	ECU7
Certification	CE
Max User Weight	150kg/330lbs
Brake Type	Self-generating
Resistance Brake Power	300W
Resistance Levels	20
Crank	Standard
Pedal	Weighted pedal with skate-style clip
Flywheel Weight	8kg
Handle bar Control	3 riding positions , with contact heart rate grips
Console Display	6 LED windows +dot Matrix LED
Console Readouts	Speed, Time, Calorie, RPM, Distance, Heart rate, Resistance, etc.
Metric/English	Metric&English
Programs	12
HR Monitor	Contact&Telemetry
Accessory Storage	Yes
Special Features	On-your-finger-tips, ergonomically designed handle bars, two-sided pedals, k-o-p-s biomechanics, easy to service
Gross Weight	78.5kg/172.7lbs
Net Weight	67.4kg/148.3lbs
Product Dimension	1132×628×1478(mm)/ 44.6"×24.7"×58.2"
Packing Size	1155×445×730(mm)/ 45.5"×17.5"×28.8"
40GP	156Sets

GU500
UPRIGHT BIKE



Model	GU500
Power Supply	300W
Product Dimension	1164 × 608 × 1511 (mm) / 45.8" × 23.9" × 59.5"
Resistance Levels	20
Resistance System	Magnetic
HR Monitor	Contact
Max User Weight	120kg/264.6lbs
Net Weight	58kg/127.9lbs
Console Display	7" LCD
Programs	13

RECUUMBENT BIKE



RR970
RECUMBENT BIKE



Model	RR970
Certification	CE
Max User Weight	180kg/396lbs
Electrical Receptacle & Plug	220V-240V
Brake Type	Self powered hybrid brake
Resistance Brake Power	450W
Resistance Levels	25
Crank	Oversize
Pedal	Oversize dual-sided pedals with integrated straps
Flywheel Weight	9kg
Handle bar Control	Ergonomically designed seat-side handles with contact heart rate grips on-your-finger-tips control
Console Display	15.6" TFT
Console Readouts	Resistance, time, distance, calories, HR, RPM
Language	EN/CN/FR/DE/ES/PT/IT/RU/JP/KR
Metric/English	Metric&English
Entertainment	Multiple built-in apps
Programs	5
HR Monitor	Contact&Telemetry
Accessory Storage	Yes
Charging Unit	Wireless
USB Data Exchange	Yes
Multi-language Display	Yes
Gross Weight	106.5kg/234.8lbs
Net Weight	88.6kg/195.3lbs
Product Dimension	638 × 1651 × 1366(mm) 25.1" × 65.0" × 53.8"



RR700
RECUMBENT BIKE



RR500
RECUMBENT BIKE

Model	RR700	RR500
Certification	ETL/CE/EN957	ETL/CE/EN957
Max User Weight	180kg/396lbs	160kg/352lbs
Brake Type	Self Powered Hybrid Brake	Self Powered Hybrid Brake
Resistance Brake Power	300W	350W
Resistance Levels	25	20
Crank	Oversized	Standard
Pedal	Oversize dual-sided pedals with integrated straps	Single sided weighted pedal
Flywheel Weight	9kg	9kg
Handle bar Control	ErgoNomically designed seat-side handles with contact heart rate grips on-your-finger-tips control	ErgoNomically designed seat-side handles with contact heart rate grips on-your-finger-tips control
Console Display	6 Windows+Dot Matrix	7Windows +Dot Matrix
Console Readouts	Distance, time, speed, watt, calories, heart rate	Distance, time, speed, watt, calories, RPM, heart rate
Metric/English	Metric&English	Metric&English
Programs	7	11
HR Monitor	Contact&Telemetry(polar)	Contact&Telemetry
Accessory Storage	Yes	Yes
Special Features	On-your-finger-tips, Ergonomically designed handle bars, Two-sided pedals, K-O-P-S biomechanics, Easy to service, walk-through design	On-your-finger-tips, Ergonomically designed handle bars, Two-sided pedals, K-O-P-S biomechanics, Easy to service, walk-through design
Gross Weight	104.6kg/230.1lbs	100.7kg/222lbs
Net Weight	83.0kg/182.6lbs	79.0kg/173.8lbs
Product Dimension	1651×638×1383(mm)/ 65.0"×25.1"×54.4"	1651×638×1383(mm)/ 65.0"×25.1"×54.4"
Packing Size	1615×370×850(mm)/ 63.6"×14.6"×33.5"	1615×370×850(mm)/ 63.6"×14.6"×33.5"
40HQ	129Sets	129Sets



ECR7 RECUMBENT BIKE



Model	ECR7
Certification	CE
Max User Weight	150kg/330lbs
Brake Type	Self-generating
Resistance Brake Power	300W
Resistance Levels	20
Crank	Standard
Pedal	Weighted pedal with skate-style clip
Flywheel Weight	8kg
Handle bar Control	Ergonomically designed seat-side handles with contact heart rate
Console Display	6 LED windows + dot Matrix LED
Console Readouts	Speed, Time, Calorie, RPM, Distance, Heart rate, Resistance, etc.
Metric/English	Metric&English
Programs	12
HR Monitor	Contact&Telemetry
Accessory Storage	Yes
Special Features	On-your-finger-tips, ergonomically designed handle bars, two-sided pedals, k-o-p-s biomechanics, easy to service
Gross Weight	100.7kg/ 221.5lbs
Net Weight	83.2kg/183.0lbs
Product Dimension	1670×634×1326(mm)/65.7"×25.0"×52.2"
Packing Size	1775×445×730(mm)/70.0"×17.5"×28.7"
40GP	96Sets

GR500
RECUMBENT BIKE



Model	GR500
Power Supply	300W
Product Dimension	1671 × 643 × 1244 (mm) / 65.8" × 25.3" × 49.0"
Resistance Levels	20
Resistance System	Magnetic
HR Monitor	Contact
Max User Weight	120kg/264.6lbs
Net Weight	72.5kg/159.8lbs
Console Display	7"LCD
Programs	13



ELLIPTICAL

RE970 ELLIPTICAL



Model	RE970
Certification	CE
Max User Weight	160kg/352lbs
Electrical Receptacle & Plug	220V-240V
Power Supply	60W
Brake Type	Self Powered Hybrid Brake
Resistance Brake Power	350W
Resistance Levels	25
Electrical Receptacle & Plug	Yes
Stride Length	533mm/21"
Pedal	Pedal with cushioned gel pads
Pedal Spacing	1"
Step-up Height	190mm/7.5"
Handle bar Control	Handle bar Control; ABS+TPU coated handlebars
Console Display	15.6" TFT
Console Readouts	Resistance, time, distance, calories, HR, RPM
Language	EN/CN/FR/DE/ES/PT/IT/RU/JP/KR
Metric/English	Metric&English
Entertainment	Multiple built-in apps
Programs	5
HR Monitor	Contact&Telemetry
Accessory Storage	Yes
Charging Unit	Wireless
USB Data Exchange	Yes
Multi-language Display	Yes
Gross Weight	174.9kg/385.6lbs
Net Weight	118kg/260.1lbs
Product Dimension	742×2113×1610(mm) 29.2"×83.2"×63.4"



RE700
ELLIPTICAL



RE500
ELLIPTICAL

Model	RE700	RE500
Certification	CE,ETL,EN957	CE,ETL,EN957
Max User Weight	160kg/352lbs	160kg/352lbs
Electrical Receptacle & Plug	No	No
Brake Type	Self Powered Hybrid Brake	Self Powered Hybrid Brake
Resistance Brake Power	350W	350W
Resistance Levels	25	20
Stride Length	533mm/21"	533mm/21"
Pedal	Pedal with cushioned gel pads	Pedal with cushioned gel pads
Pedal Spacing	1"	1"
Step-up Height	190mm/7.5"	190mm/7.5"
Handle bar	Handle bar Control; ABS+TPU coated handlebars	PVS handlebars
Console Display	6 Windows+Dot Matrix	7 Windows+Dot Matrix
Console Readouts	Speed, Time, Calorie, RPM, Distance, Heart rate, Resistance, etc.	Speed, Time, Calorie, RPM, Distance, Heart rate, Resistance, etc.
Metric/English	Metric&English	Metric&English
Programs	7	11
HR Monitor	Contact&Telemetry	Contact&Telemetry
Accessory Storage	Cup holder, Magazine Holder, Phone Holder	Cup holder, Magazine Holder, Phone Holder
Special Features	On-your-finger-tips, Ergonomically designed handle bars, Easy to service	On-your-finger-tips, Ergonomically designed handle bars, Easy to service
Gross Weight	174.5kg/383.9lbs	175.4kg/385.9lbs
Net Weight	118.1kg/259.8bs	119.4kg/262.7lbs
Product Dimension	2180×742×1610(mm)/ 85.8" ×29.2" ×63.4"	2180×742×1610(mm)/ 85.8" ×29.2" ×63.4"
Packing Size	2220×650×1090(mm)/ 87.4"×25.6"×42.9"	2220×650×1095(mm)/ 87.4" × 25.6"×43.1"
40GP	36Sets	36Sets



FGE300
ELLIPTICAL



Powered-off State

Concealed Capacitive Touch LED Mirror Screen

Featuring a concealed capacitive touch button design for responsive and pressure-free interactions, enhancing product longevity.

The screen, in its powered-off state, seamlessly blends into a unified black mirror surface, elevating the overall aesthetic appeal.



Concealed Maintenance Port

Ease of Maintenance

Featuring a concealed maintenance port design, simply open the hidden cover to access and maintain the core components, reducing maintenance costs.



Convenient Fingertip Control System

Featuring both fixed and dynamic training dual-position handlebar design, allowing free selection of handlebar positions based on different training modes.

The fixed handlebar position includes a resistance adjustment button for quick intensity customization.

250W Self-Generating Electromagnetic Resistance System + 32-Level Resistance Adjustment

- 250W Self-Generating Resistance System: Satisfy high-intensity training needs; the self-generating system is environmentally friendly, eliminating the need for external power sources, providing flexibility in placement without being constrained by power outlet locations.
- 32-Level Fine-tuned Resistance Levels: Precise resistance adjustment for smooth transitions, coupled with various training modes to meet diverse training requirements.

Model	FGE300
Console	4 LED Windows+8*20 Matrix
Program	12 Preset Programs, 5 Custom Programs (U0~U4), 1 Constant Power Program, 4 HR Programs, 5 Target Programs (Time, Distance, Calories, Power, HR), 1 HR Recovery Test
Console Readouts	Speed, RPM, Distance, Calories, Power, Time, Resistance Level, HR
Power Requirement	Self-generating
Resistance	32 Levels Electromagnetic Resistance System, 250W
Flywheel	10.8kg(Self-generating Module)
Stride Length	20" (508mm)
Pedal Distance	255mm
Step-up Height	330mm
Sliding Rail	4
HR Monitor	Contact
Quick Button	6 Direct Resistance Selection Buttons + Fingertip Control System
Product Dimension	1750×630×1900mm/68.9×24.8×74.8(in)
Packing Dimension	1840×560×825mm/72.4×22.0×32.5(in)
Max User Weight	150kg/330.7lbs
Net Weight	115kg/253.5lbs
Gross Weight	133kg/293.2lbs



SPIN BIKE



PS460 SELF-GENERATING MAGNETIC CYCLE

Resistance System	Magnetic
Resistance Power	400W
Resistance Level	1-20
Emergency Stop	Push
Flywheel	Aluminum
Flywheel Weight	3.5kg
Pulley	Aluminum
Drivetrain	Belt
Drivetrain Ratio	1:10
Frame Material	Steel
Adjustment Type	Aluminum
Pedal	Dual-sided vp pedal
Shaft	φ25
Bearing	TPI
Handlebar	Multi-position, Soft PVC
Handlebar Adjustment	Vertical&Horizontal
Saddle	Ultra-padded sport saddle
Saddle Adjustments	Vertical&Horizontal
Console Display	4.3"LCD
Console Readouts	Resistance Level, Time, Speed(AVG/MAX), Distance, Watt(AVG/MAX), RPM(AVG/MAX), Heart Rate(AVG/MAX), Calories
Water Bottle Holder	Double
Maximum User Weight	150kgs/330lbs
Gross Weight	56.6kg/124.8lbs
Net Weight	50.3kg/110.9lbs
Product Dimension	1317×604×1057(mm) 51.9"×23.8"×41.6"
Packing size	1310×315×1000(mm) 51.6"×12.4"×39.4"

The console is powered by the bike's self-generated electricity and supports Bluetooth protocols, allowing it to connect with the majority of third-party apps available in the market.



Dual cup holders for intense training.



Dual-sided pedals allow riders to wear either cycling or athletic shoes.



Larger main frame, over-sized axis and pedal shaft ensure reliable quality.



Magnetic brake system provides more stable resistance, and more convenient adjustment.



V structure, 164mm Q-FACTOR allows ideal riding position.



Seat and handles are adjustable horizontally and vertically. Aluminum post and newly designed knob allows convenient adjustment.



Rear aluminum flywheel is waterproof. The plastic edge shroud ensures riding safety.

Maintenance-free belt offers more quiet and smoothly riding experience.



Tension unit for stretch before and after riding.



PS450 MAGNETIC INDOOR GROUP CYCLE

Resistance System	Magnetic
Emergency Stop	Push
Flywheel	Aluminum
Flywheel Weight	3.5kg
Pulley	Aluminum
Drivetrain	Belt
Drivetrain Ratio	1:10
Frame Material	Steel
Adjustment Type	Aluminum
Pedal	Dual-sided vp pedal
Shaft	φ25
Bearing	TPI
Handlebar	Multi-position, Soft PVC
Handlebar Adjustment	Vertical&Horizontal
Saddle	Ultra-padded sport saddle
Saddle Adjustments	Vertical&Horizontal
Water Bottle Holder	Double
Maximum User Weight	150kgs/330lbs
Gross Weight	56.6kg/124.8lbs
Net Weight	50.3kg/110.9lbs
Product Dimension	1272×604×1057(mm) 50.1"×23.8"×41.6"
Packing size	1310×315×1000(mm) 51.6"×12.4"×39.4"



CONSOLE



PS300



PS303



- **Handlebar**
Vertically adjustable with nice hand feeling. Multiple handle positions can meeting various training needs.
- **Frame**
Double-oval tube and anti-rust steel frame makes extraordinary appearance.
- **Brake**
Reliable Nylon nob brake. Coated steel cup holder is easy to access.
- **Resistance**
Long-lasting pedals and classic fly wheel driving system brings nice training experience to users.
- **Seat**
Precision casting seat part combined with chromium-plated steel adjusting tube make it easy to adjust position. Ergonomic seat pad provides comfortable training.

PS300 SPINNING BIKE

Resistance System	Wool brake
Emergency Stop	Push
Flywheel Weight	20kg/44lbs
Drivetrain	Chain
Pedal	Dual-sided vp pedal
Handlebar	Multi-position, Soft PVC
Handlebar Adjustment	Vertical & Horizontal
Max User Weight	150kg/330lbs
Gross Weight	66.3kg/145.9lbs
Net Weight	58.0kg/127.6lbs
Product Dimension	1188×528×1170(mm) 46.8"×20.8"×46.1"
Packing Size	1100×330×870(mm) 43.3"×13.0"×34.3"
40HC Container Count	222

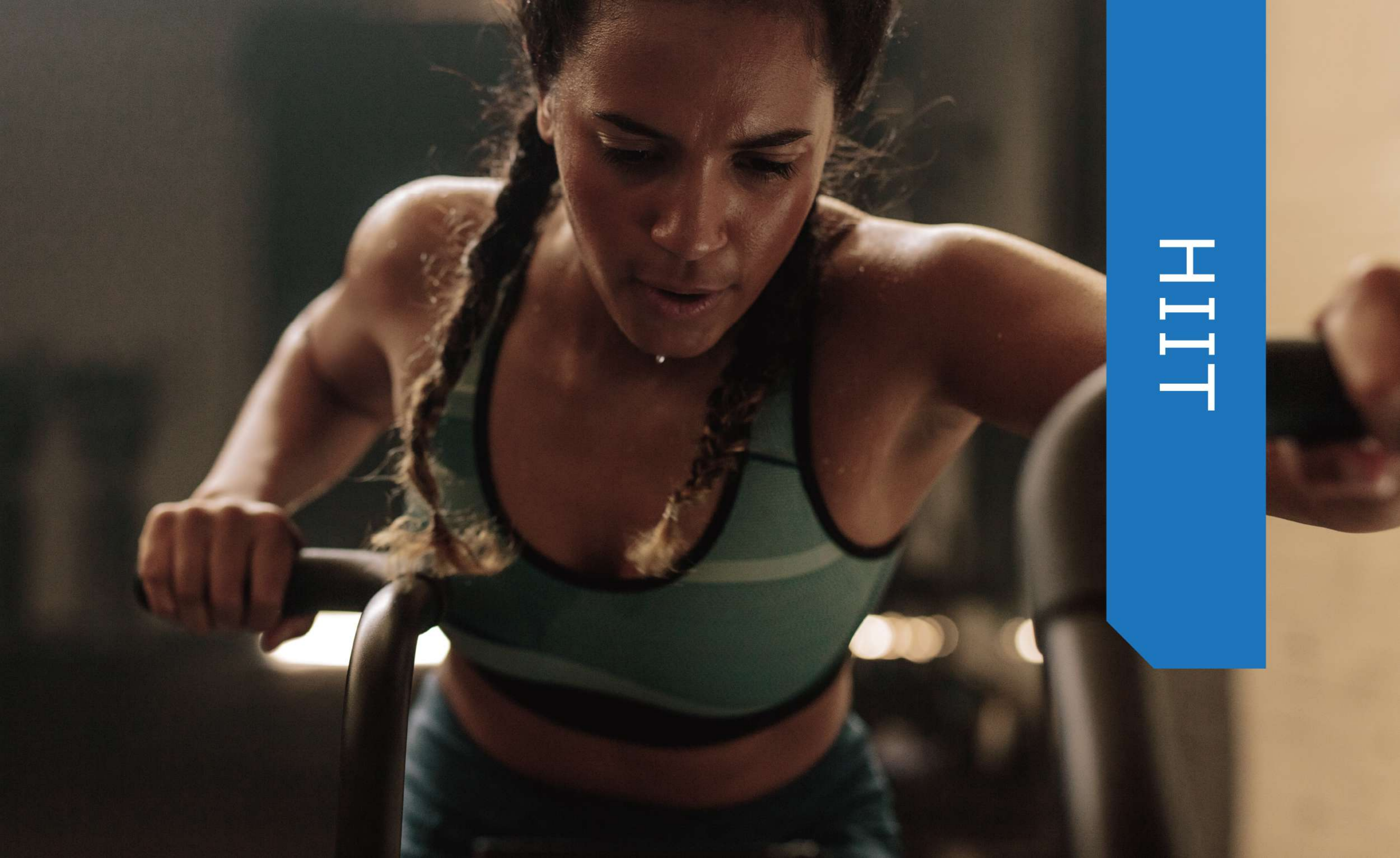

HITT

HSR007 SKI & ROW MULTIPLE TRAINING MACHINE



MARS (Magnetic & Air Resistance System) allows users to control their exertion and resistance at all time. The MARS system with 20 settings so you can change the resistance to suit your performance.



Adjustable pedals and ergonomic handle bars accommodate different users' need. The sturdy legs provide users a comfortable and stable movement.



Heart rate telemetry system helps users to monitor intensity of the workout. Adjustable angle of console provides users with the best viewing experience in using condition.

High intensity cords achieve the maximum strength test up to 1,000,000 times ensuring the high quality of products.



Ergonomic seat enables users to train comfortably. Light-weight aluminum and stainless steel made slide rail allows users to train intensively and provide a low maintenance.

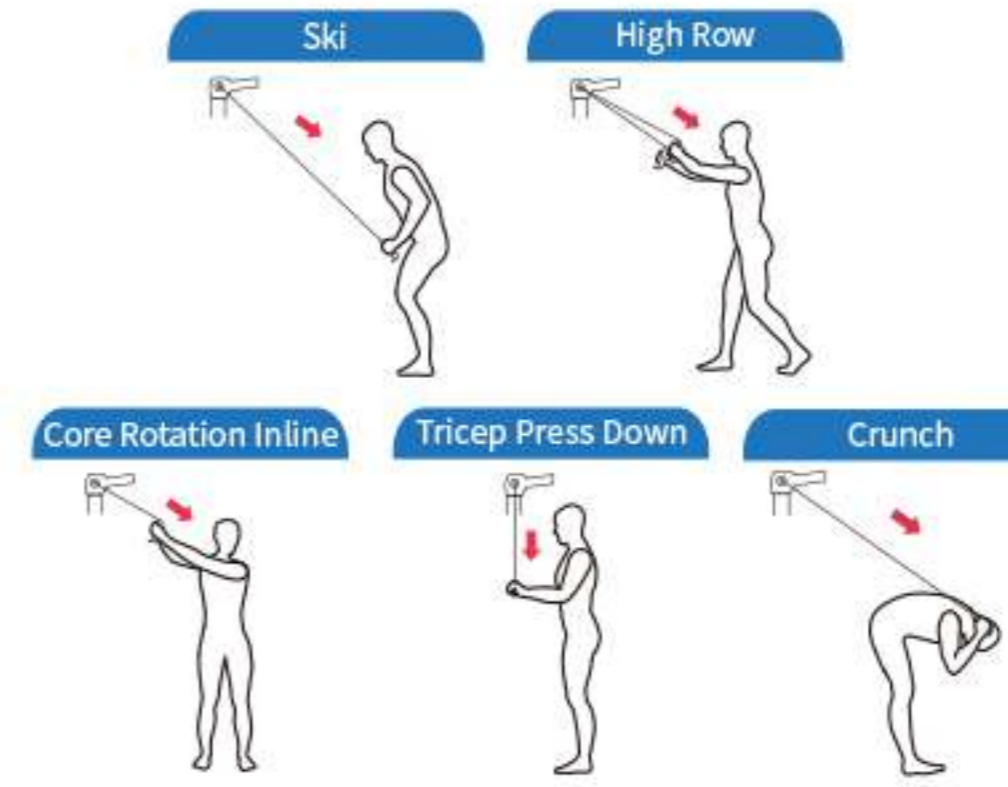

Skiing bar made of TPR materials allows for a comfortable grab feeling.



A folded Ski&Row saves 48% floor space comparing with rower form.

The transport wheels make it easy to place to a workout space.



A folding lock-up system ensures safety in daily using condition.



The SKI&ROW can be used in standing form, which provides upper body training and core training. Optional foot straps help users to train lower body and complete the workout shown below:



● MARS (Magnetic & Air Resistance System)

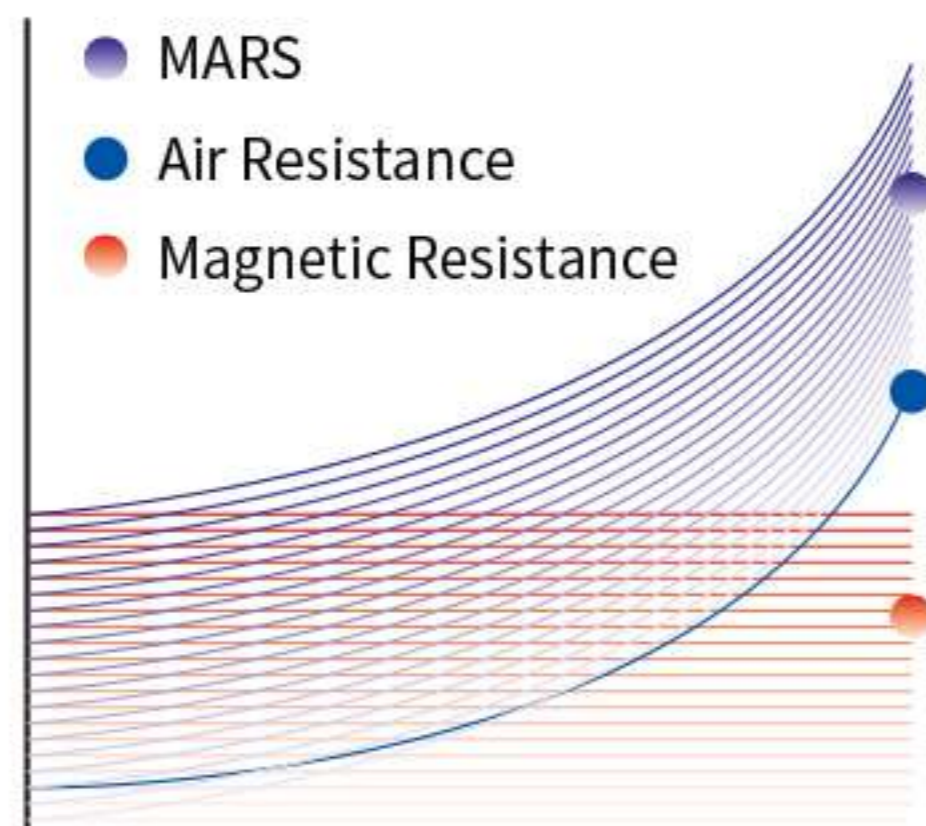

SKI & ROW Multiple Training Machine MARS (Magnetic & Air Resistance System) add a further resistance to the air resistance. The MARS system has 20 precise resistance levels. Through the console, users can easily adjust the resistance at all time.

Model	HSR007
Maximum User Weight	150kg / 330lbs
Drive Model	Belt
Handlebar Design	Rowing Bar & Skiing Bar
Flywheel Weight	4.1kg
Special Features	Provided Rowing & Skiing Training
Resistance Design	MARS (Magnetic & Air Resistance System)
Resistance Power	300W
Resistance Levels	20
Console Display	5" LCD display with 8 readout windows
Console Readouts	Time, Stroke Rate, Pace, Distance, Watts, Calories, Heart Rate, Level
Programs	5(Time/Distance/Calorie Target, Interval Time/Distance)
HR Monitor	Bluetooth, ANT+
Power Requirements	4 C cell batteries
Product Dimension	Horizontal Form: 2620×883×1060(mm)/103.1"×34.8"×41.7" Vertical Form: 1360×883×2140(mm)/53.5"×34.8"×84.3
Seat Height	513mm/ 20.2"
Monorail	1663mm/ 65.5" (Aluminum)
Net Weight	66.5kg/147lbs
Packing Size	Box 1: 1805×565×170(mm)/71.1"×22.2"×6.7" Box 2: 1075×575×680(mm)/42.3"×22.6"×16.8"
40HQ Container Count	108

● Space Saving Design

Thanks to the innovative design, the folded SKI & ROW Multiple Training Machine saves 48% space comparing with rowing form. Therefore, the SKI & ROW Multiple Training Machine as a commercial grade equipment is also suitable for the small fitness studio or residential.



HSR005 Rower



Heart rate telemetry system helps users to monitor intensity of the workout. Your exercise data can be easily synchronized via Bluetooth. Adjustable angle of console provides users with the best viewing experience in using condition

Seamless air resistance shifting

High durable chain can ensure the quality under intensive usage

Ergonomic seat enables users to train comfortably. Light-weight aluminum and stainless steel made slide rail allows users to train intensively and provide a low maintenance

Adjustable pedals and ergonomic handle bars accommodate different users' need. The sturdy legs provide users a comfortable and stable movement

Model	HSR005
Maximum User Weight	150kg / 330lbs
Drive Model	Chain
Handlebar Design	Rowing Bar
Special Features	Provided Rowing
Resistance Design	Air Resistance
Console Display	5" LCD display with 8 readout windows
Console Readouts	Time, Stroke Rate, Pace, Distance, Watts, Calories, Heart Rate, Level
Programs	5(Time/Distance/Calorie Target, Interval Time/Distance)
HR Monitor	Bluetooth, ANT+
Power Requirements	4 C cell batteries
Product Dimension	2240×365×1060(mm) 88.2"×14.4"×41.7"
Seat Height	513mm/ 20.2"
Monorail	1463mm/ 57.6" (Aluminum)

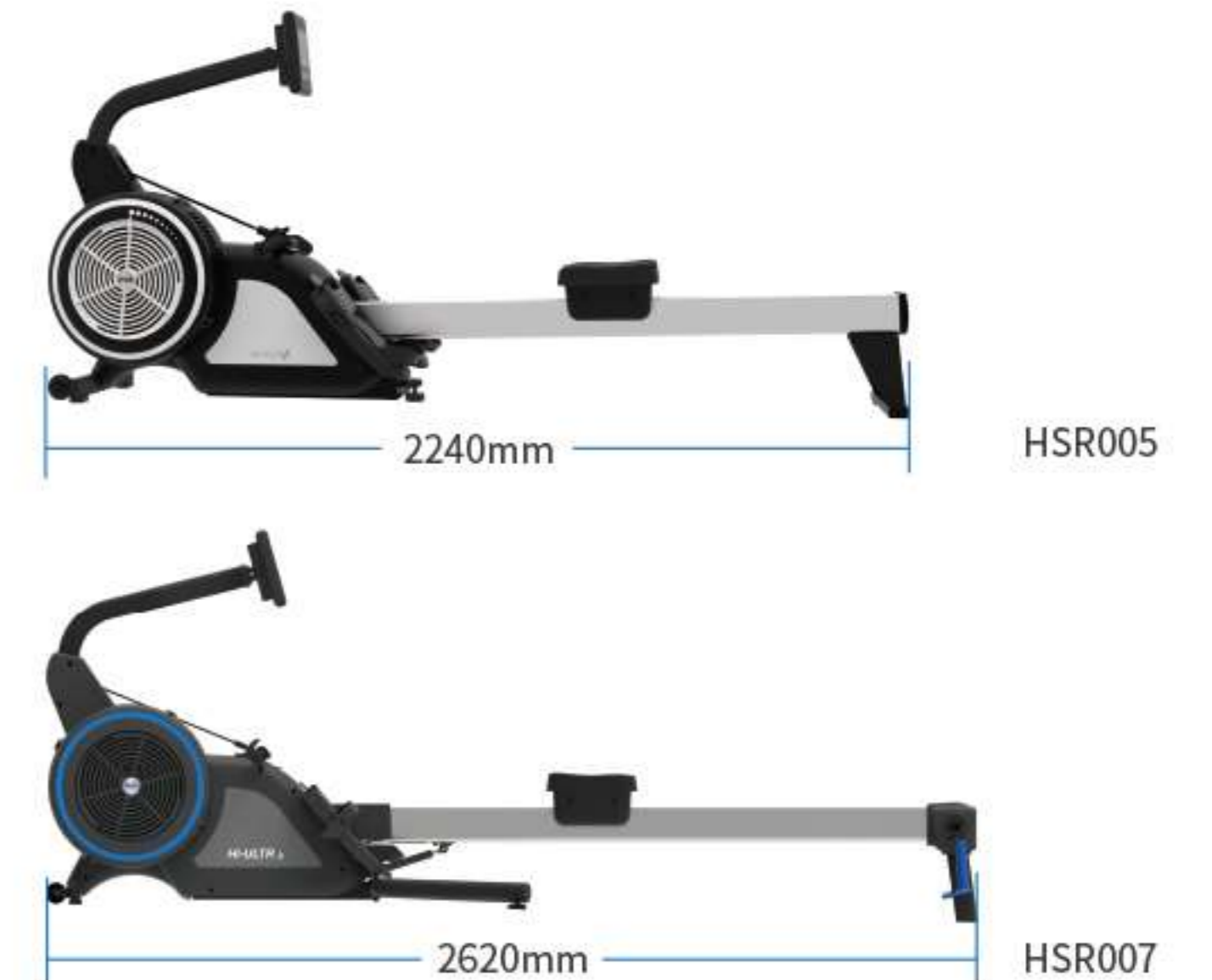

HB005 ULTRA BIKE SELF-GENERATING

The resistance is delivered by fan, which is driven by power and speed pedal along with two handles that move back and forth. Users are able to determine intensity level and resistance.

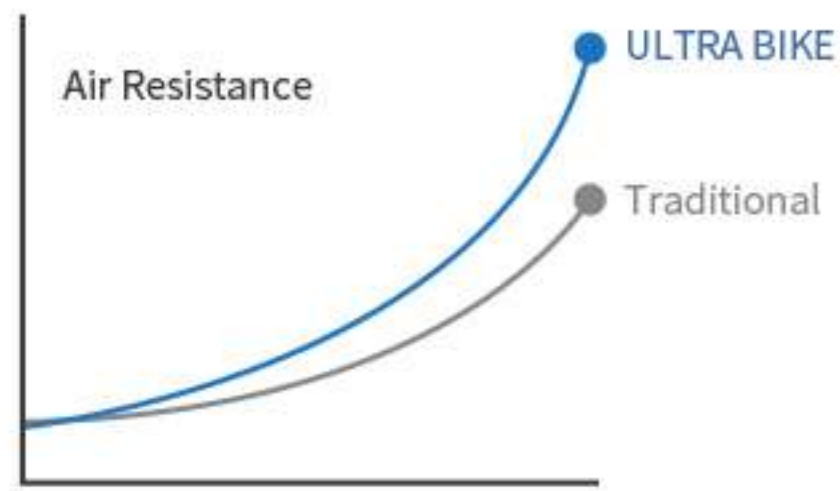

26 ABS blades molded into one piece which makes it stabilized and more quiet than traditional steel blades in using condition.



The workout data can be synchronized to your smart devices via Bluetooth or ANT+. Then you can track the data with 3rd party applications which manage your training more scientific. It helps users to make a more reasonable training plan.



Consider electroplated steel gets rust easily, the seat support and pedals of ULTRA BIKE is made of aluminum alloy, which is less prone to corrosion, helping to provide long service life.



Compared to ordinary ULTRA BIKE with its chain always sways and bumps and needs scheduled maintenance. ULTRA BIKE's V-Belt drive provides smooth and consistent ride without extra maintenance or high cost.

Model	HB005
Maximum User Weight	150kg / 330lbs
Resistance	Air Resistance
Drive Model	Belt Drive
Pedals & handle bars	Synchronized Motion
Pedals	Double Faced Aluminum Alloy
Footholds	Aluminum
Crank	Oversize
Console Display	5"LCD Screen
Console Readouts	Time, Speed/Average Speed, Calories/Average Calories, Distance, RPM/Average RPM, Watt/Average Watt, Heart Rate/ Average Heart Rate
Programs	3 target programs (Time, Distance, Calories), 3 Heart Rate Programs (65%,75%,85%), 4 Interval Programs (3 time interval and 1 distance interval)
Heart Rate Monitor	Bluetooth, ANT+
Cup Holder	Yes
Fan Size	26 inches
Fan Blades	26 ABS Curved blades
Power Requirements	4 C Cell batteries
Product Dimension	1308×712×1349(mm)/51.5"×28.0"×53.1"
Net Weight	63.3kg/139.6lbs
Gross Weight	79.8kg/175.9lbs
Packing Size	1355×400×905(mm)/52.6"×15.7"×35.6"



ULTRA BIKE enables users to do upper body training, lower body training and total body training. It helps to improve your body coordination and meets training demands of various people.



HC005 CLIMBER

The HC005 Climbing Machine is an aerobic exercise and full-body workout fitness equipment that provides low-impact joint aerobic exercise. It simulates climbing, mountaineering, and stair climbing to offer a comprehensive aerobic workout targeting the whole body, lower limbs, core muscles, and cardiovascular system, improving lung and heart function, endurance, and overall health.



With three handle positions, the product accommodates users of various heights, ensuring adaptability and comfort during training.



The product uses magnetic resistance with electric adjustment for convenient operation, offering 20 levels of smooth resistance to meet various training needs. It also features 8 training modes to accommodate diverse user requirements.



Featuring LCD display and touch interaction, the product is user-friendly and futuristic. The tempered glass panel enhances durability.



The product also offers stepping and stair climbing functions to achieve multi-functionality, catering to the diverse training needs of users. The handle grips are covered with soft rubber for increased comfort during use.



Model	HC005
Product Weight	92kg / 202.8lbs
Product Dimensions	1215×1110×2500(mm)/47.8"×43.7"×98.4"
Climbing Angle	75°
Maximum Climbing Stride	500mm
Maximum User Weight	160kg
Adjustable Resistance	20 levels
Electric Resistance	Yes
Adjustment Function	
Input Power Voltage	AC100-240V
Charging Reminder	Yes
Heart Rate Display	Yes
Bluetooth Connectivity	Yes
Stepper Function	Yes
Training Modes	8 types



EXOFORM



EXOFORM >>>

Uniformly low profile at 1492mm is designed by American team. Translucent shroud at thickness 3.2mm with smooth pattern is in injection molding, which designed elegantly and ensures ultra durability and non-deformation

Build-in console, which is well designed by American UI team, displays reps and time

The upright tubes are with special tube at size 72.8×141.7×3mm, and the functional part with race track tube at size 40×133×3mm. Tubes apply double powder-coated & painting process which ensure high-quality and ultra durability

The steel guide rod (diameter:19mm) is anti-corrosion coated and polished which ensures smoothly travel and rust-proof

Friendly designed iPad and bottle holders are separated to meet various requirement

The 5LBS incremental weight is to meet users requirement

All the hardware parts exposed are nickel plated or stainless steel. The NBK bearing is applied

Meet EN957 safety regulation

Ergonomically designed handle bars, which is patented, are with TPU material and aluminium grip ring. The concise design offers comfort and safety

Ergonomically designed upholstery is with PU foam which offers comfort and safety protection

Belt and cable driving system are both applied. Self-lubricate American Loss cable with nylon-coated 12 complex fiber ensures service life 300,000 times. The belt is with steel wire embedded which ensures ultra durability and long lifetime

With spiral spring assistance system, the patented 3-linkage seat adjustment is concisely designed, cost-saving and offers easy installment

All dynamic components are shielded for safety purpose

Gas spring for resetting



* WEIGHT STACK SOLD SEPARATELY

OPTION 1	160lbs/68.3kg
OPTION 2	200lbs/85.5kg
OPTION 3	235lbs/102.8kg
OPTION 4	295lbs/129.2kg



* COLOR OPTIONAL.



FE9701 CHEST PRESS

Dimension (L×W×H)	1230x1570x1490(mm) 48.4x61.8x58.7 (in)
Net Weight	169.7kg/373.3lbs



FE9702 LAT PULLDOWN

Dimension (L×W×H)	1304×1226×2109 (mm) 51.3x48.2x83.0 (in)
Net Weight	177.7kg/390.9lbs

FE9703 ARM CURL

Dimension (L×W×H)	1149x1567x1490(mm) 45.2x61.7x58.7 (in)
Net Weight	169.1kg/372lbs



FE9704 PECTORAL

Dimension (L×W×H)	1197x1551x1489 (mm) 47.1x61.1x58.6 (in)
Net Weight	166.2kg/365.6lbs



FE9705 LEG EXTENSION

Dimension (L×W×H)	1264x1239x1489(mm) 49.8x48.8x58.6 (in)
Net Weight	169.6kg/373.1lbs



FE9708 ABDUCTOR/ADDUCTOR

Dimension (L×W×H)	1776x1546x1488 (mm) 69.9x60.9x58.6 (in)
Net Weight	165.8kg/364.8lbs



FE9706 SEATED LEG CURL

Dimension (L×W×H)	1240x1541x1489 (mm) 48.8x60.7x58.6 (in)
Net Weight	183.6kg/403.9lbs



FE9710 LEG PRESS

Dimension (L×W×H)	1781×1293×1491(mm) 70.1x50.9x58.7 (in)
Net Weight	279kgs/613.8lbs



FE9712 SHOULDER PRESS

Dimension (L×W×H)	1762x1422x1492(mm) 69.4x55.9x58.7 (in)
Net Weight	168.7kg/371.1lbs



FE9714 ABDOMINAL

Dimension (L×W×H)	1383×1202×1491(mm) 54.4x47.3x58.7 (in)
Net Weight	141.5kg/311.3lbs



FE9715 PEC FLY/REAR DELT

Dimension (L×W×H)	1296x1758x1490(mm) 51x69.2x58.7 (in)
Net Weight	160.7kg/353.5lbs



FE9716 CALF RAISE

Dimension (L×W×H)	1265x1186x1721(mm) 49.8x46.7x67.8 (in)
Product Weight	167.8kg/369.2lbs





FE9718 TORSO ROTATION

Dimension (L×W×H)	1293x1346x1490 (mm) 50.9x53.0x58.7 (in)
Net Weight	176kg/387.2lbs



FE9720 WEIGHT ASSISTED CHIN/DIP COMBO

Dimension (L×W×H)	1750x1378x2197 (mm) 68.9x54.2x86.5 (in)
Net Weight	243.5kg/535.7lbs



FE9719 ROW

Dimension (L×W×H)	1996×1127×1492(mm) 78.6x44.4x58.7 (in)
Net Weight	174.8kg/384.6lbs



FE9721 PRONE LEG CURL

Dimension (L×W×H)	1606×1193×1492mm 63.2x47x58.7 (in)
Net Weight	154.2kg/339.2lbs





FE9723 TRICEP

Dimension (L×W×H)	1149x1580x1490 (mm) 45.2x62.2x58.7 (in)
Net Weight	163.5kg/359.7lbs



FE9724 LATERAL RAISE

Dimension (L×W×H)	1266x1261x1491 (mm) 49.8x49.6x58.7 (in)
Net Weight	187.5kg/412.5lbs



FE9726 GLUTE

Dimension (L×W×H)	1307x1483x1488 (mm) 53.9x58.4x58.6 (in)
Net Weight	168.5kg/370.7lbs



FE9732 BACK EXTENSION

Dimension (L×W×H)	1383×1203×1492(mm) 54.4x47.4x58.7 (in)
Net Weight	185.4kg/407.9lbs



* COLOR OPTIONAL



FE9701 CHEST PRESS



FE9702 LAT PULLDOWN



FE9703 ARM CURL



FE9704 PECTORAL



FE9718 TORSO ROTATION



FE9719 ROW



FE9720
WEIGHT ASSISTED CHIN/DIP COMBO



FE9721
PRONE LEG CURL



FE9705
LEG EXTENSION



FE9706
SEATED LEG CURL



FE9708
ABDUCTOR/ADDUCTOR



FE9710 LEG PRESS



FE9723 TRICEP



FE9724 LATERAL RAISE



FE9726 GLUTE



FE9732 BACK EXTENSION



FE9712 SHOULDER PRESS



FE9714 ABDOMINAL



FE9715
PEC FLY/REAR DELT



FE9716 CALF RAISE

SL95 Line >> >

Translucent shroud at thickness 3.2mm with smooth pattern is in injection molding, which designed elegantly and ensures ultra durability and non-deformation

Meet EN957 safety regulation

Ergonomically designed handle bars, which is patented, are with TPU material and aluminium grip ring. The concise design offers comfort and safety

Ergonomically designed upholstery which offers comfort and safety protection

Belt and cable driving system are both applied. Self-lubricate American Loss cable with nylon-coated 12 complex fiber ensures service life 300,000 times. The belt is with steel wire embedded which ensures ultra durability and long lifetime

With spiral spring assistance system, the patented 3-linkage seat adjustment is concisely designed, cost-saving and offers easy installment

All dynamic components are shielded for safety purpose

Gas spring for resetting

Friendly designed storage tank can meet various needs

The upright tubes are with special tube at size 72.8×141.7×3mm, and the functional part with race track tube at size 40×133×3mm. Tubes apply double powder-coated & painting process which ensure high-quality and ultra durability

Weight stack: 19mm full steel plate. Weight options-160/200/235/295Lbs

All the hardware parts exposed are nickel plated or stainless steel. The NBK bearing is applied

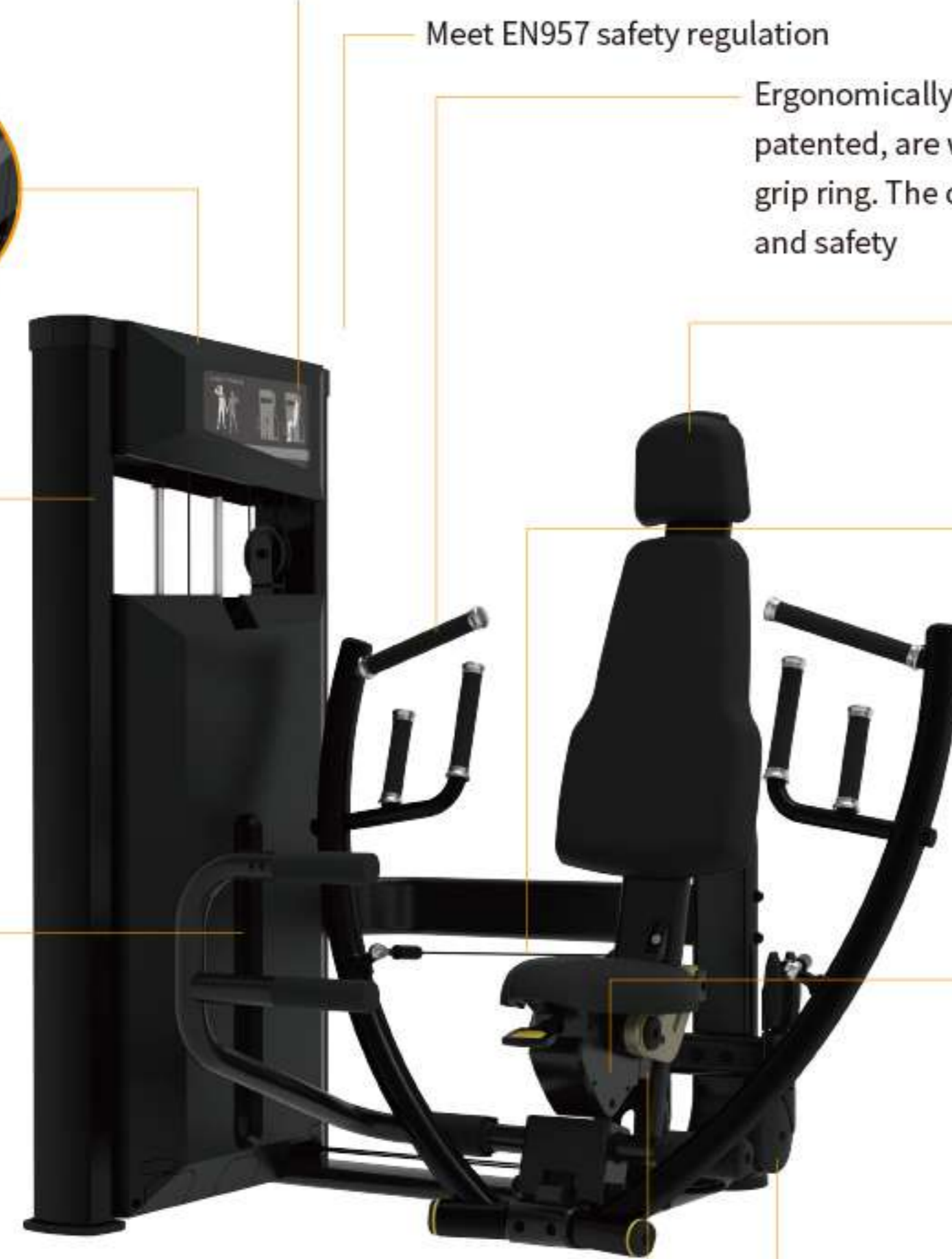

SL9501 CHEST PRESS

PRODUCT DIMENSION (LxWxH)	1552x1231x1503 (mm) 61.1x48.5x59.2 (in)
PRODUCT WEIGHT	163.5kg/360.5lbs



SL9502 DIVERGING LAT PULLDOWN

PRODUCT DIMENSION (LxWxH)	1305x1224x2109 (mm) 51.4x48.2x83.0 (in)
PRODUCT WEIGHT	172kg/379.2lbs

SL9503 ARM CURL

PRODUCT DIMENSION (LxWxH)	1122x1583x1563 (mm) 44.2x62.3x61.5 (in)
PRODUCT WEIGHT	162kg/357.1lbs





SL9505 LEG EXTENSION

PRODUCT DIMENSION (LxWxH)	1401x1227x1563 (mm) 55.2x48.3x61.5 (in)
PRODUCT WEIGHT	145.1kg/319.9lbs

SL9506 SEATED LEG CURL

PRODUCT DIMENSION (LxWxH)	1495x1275x1563 (mm) 58.9x50.2x61.5 (in)
PRODUCT WEIGHT	162.8kg/358.9lbs



SL9508 ABDUCTOR/ADDUCTOR

PRODUCT DIMENSION (LxWxH)	784x1636x1563 (mm) 30.9x64.4x61.5 (in)
PRODUCT WEIGHT	144.8kg/319.2lbs

SL9509 TOTAL HIP

PRODUCT DIMENSION (LxWxH)	972x1381x1564 (mm) 38.3x54.4x61.6 (in)
PRODUCT WEIGHT	178.6kg/393.7lbs



SL9510 LEG PRESS

PRODUCT DIMENSION (LxWxH)	1813x1176x1562 (mm) 71.4x46.3x61.5 (in)
PRODUCT WEIGHT	219.3Kg/483.5lbs

SL9512 SHOULDER PRESS

PRODUCT DIMENSION (LxWxH)	1550x1490x1564 (mm) 61.0x58.7x61.6 (in)
PRODUCT WEIGHT	152.5kg/336.2lbs





SL9515 PEC FLY/REAR DELT

PRODUCT DIMENSION (LxWxH)	1497x1629x2048 (mm) 58.9x64.1x80.6 (in)
PRODUCT WEIGHT	141.2kg/311.3lbs

SL9516 STANDING CALF RAISE

PRODUCT DIMENSION (LxWxH)	1192x1197x1750 (mm) 46.9x47.1x68.9 (in)
PRODUCT WEIGHT	131kg/288.8lbs



SL9517 SEATED DIP

PRODUCT DIMENSION (LxWxH)	1428x1300x1564 (mm) 56.2x51.2x61.6 (in)
PRODUCT WEIGHT	150kg/330.7lbs



SL9519 VERTICAL ROW

PRODUCT DIMENSION (LxWxH)	1984x1129x1563 (mm) 78.1x44.4x61.5 (in)
PRODUCT WEIGHT	159.7kg/352.1lbs



SL9520 WEIGHT ASSISTED CHIN DIP COMBO

PRODUCT DIMENSION (LxWxH)	1394x1608x2285 (mm) 54.9x63.3x90.0 (in)
PRODUCT WEIGHT	183.8kg/405.2lbs



SL9521 PRONE LEG CURL

PRODUCT DIMENSION (LxWxH)	1185x1443x1563 (mm) 46.7x56.8x61.5 (in)
PRODUCT WEIGHT	139.4kg/307.3lbs





SL9522 LAT PULLDOWN VERTICAL ROW

PRODUCT DIMENSION (LxWxH)	1223x1936x2231 (mm) 48.1x76.2x87.8 (in)
PRODUCT WEIGHT	139.1kg/306.7lbs

SL9528 LEG EXTENSION/LEG CURL

PRODUCT DIMENSION (LxWxH)	1351x1319x1563 (mm) 53.2x51.9x61.5 (in)
PRODUCT WEIGHT	180.1kg/397.1lbs



SL9529 MULTI PRESS

PRODUCT DIMENSION (LxWxH)	1827x1477x1672 (mm) 71.9x58.1x65.8 (in)
PRODUCT WEIGHT	178.4kg/393.3lbs

SL9524 LATERAL RAISE

PRODUCT DIMENSION (LxWxH)	1098x1284x1564 (mm) 43.2x50.6x61.6 (in)
PRODUCT WEIGHT	127.5kg/281.1lbs



SL9534 ABDOMINAL BACK EXTENSION

PRODUCT DIMENSION (LxWxH)	1112x1267x1567 (mm) 43.8x49.9x61.7 (in)
PRODUCT WEIGHT	140.1kg/308.9lbs





in impulse

ARM CURL

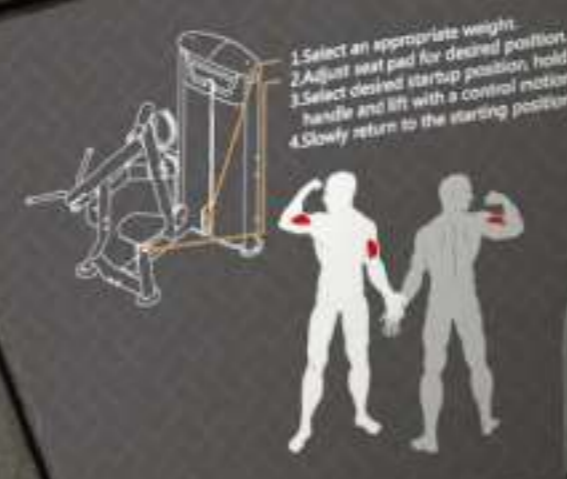

IT95 Line >>>

Tube: 3mm tube in main frame and movement parts. U-frame uses PR95x81.1x3 tube and functional parts use RT50x100

Plastic part: Injection molding for better quality

Painting: Double coated surface treatment

Incremental weight (optional): 5lbs for smaller adjustment

Weight stack: 19mm full steel plate. Weight options - 160/200/235/295Lbs

Easy to enter and exit the machine and able to adjust when in sitting position

Conform with EN957. Passed 300,000 times fatigue test and 100kg stable test

* WEIGHT STACK SOLD SEPARATELY

OPTION 1	160lbs/68.3kg
OPTION 2	200lbs/85.5kg
OPTION 3	235lbs/102.8kg
OPTION 4	295lbs/129.2kg



*COLOR OPTIONAL. Two paint colors and upholstery colors can be freely combined.

Handle: Patented ergonomic design with TPU material

Standard metal part: Nickel plated or stainless steel for better appearance and quality

Diverging motion structure allows the arm training simultaneously and alternately

Pad: Double stitch and add protect cover on the back. Various colors to choose from

Pulley: Lathed pulley with less tolerance

Cable: USA imported cable which passed more than 250 thousand times test

Bearing: Reliable Taiwan brand

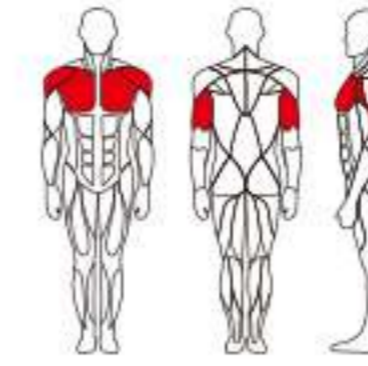

IT9501 CHEST PRESS

PRODUCT DIMENSION (LxWxH)	1475x1200x1506 (mm) 58.1x47.2x59.3 (in)
PRODUCT WEIGHT	127.4kg/280.3lbs

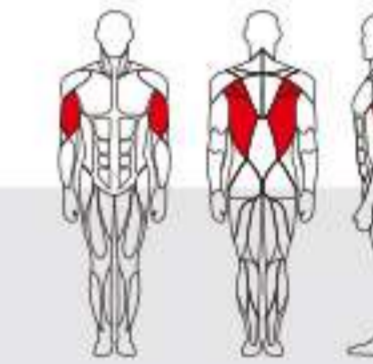

IT9502 LAT PULLDOWN

PRODUCT DIMENSION (LxWxH)	1384x1373x1889 (mm) 54.5x54.1x74.4 (in)
PRODUCT WEIGHT	147.7kg/324.9lbs

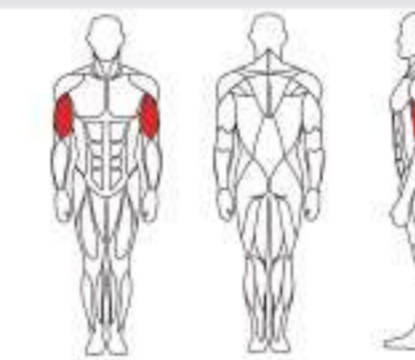

IT9503 ARM CURL

PRODUCT DIMENSION (LxWxH)	1295x1208x1506 (mm) 51.1x47.6x59.3 (in)
PRODUCT WEIGHT	115.5kg/254.1lbs



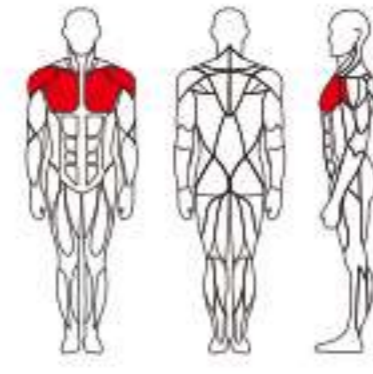

IT9504 PECTORAL

PRODUCT DIMENSION (LxWxH)	1450x1360x1510 (mm) 57.1x53.5x59.4 (in)
PRODUCT WEIGHT	132.5kg/291.5lbs

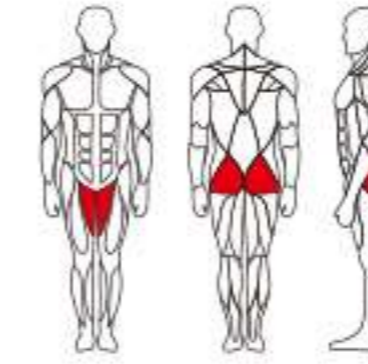

IT9508 ABDUCTOR/ADDUCTOR

PRODUCT DIMENSION (LxWxH)	1553x856x1506 (mm) 61.1x33.7x59.3 (in)
PRODUCT WEIGHT	149.6kg/329.1lbs

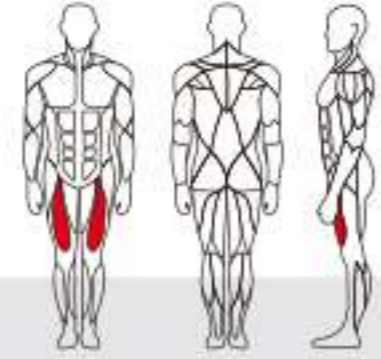

IT9505 LEG EXTENSION

PRODUCT DIMENSION (LxWxH)	1202x1189x1506 (mm) 47.3x46.8x59.3 (in)
PRODUCT WEIGHT	133.1kg/292.8lbs

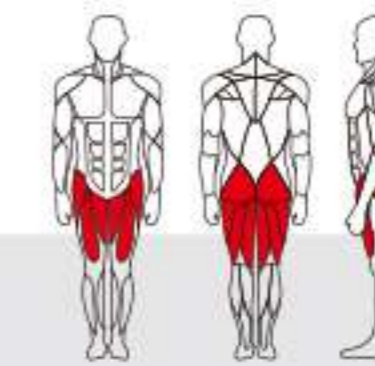

IT9509 TOTAL HIP

PRODUCT DIMENSION (LxWxH)	1292x972x1506 (mm) 50.9x38.3x59.3 (in)
PRODUCT WEIGHT	148.2Kg/326.7lbs

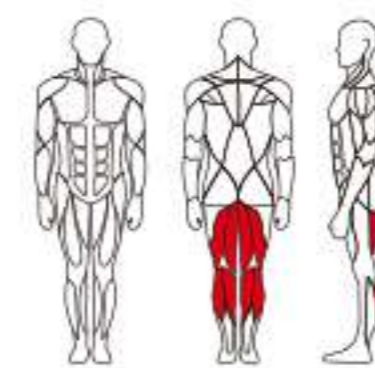

IT9506 SEATED LEG CURL

PRODUCT DIMENSION (LxWxH)	1536x1186x1506 (mm) 60.5x46.7x59.3 (in)
PRODUCT WEIGHT	149.6kg/329.1lbs

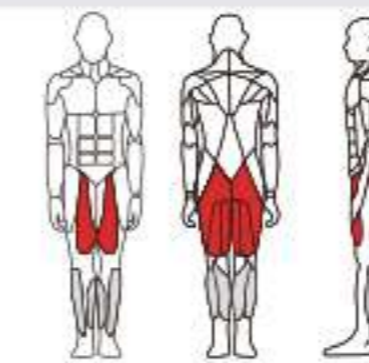

IT9510 LEG PRESS

PRODUCT DIMENSION (LxWxH)	1813x1109x1504 (mm) 71.4x43.7x59.2 (in)
PRODUCT WEIGHT	211.3kg/464.9lbs





IT9512 SHOULDER PRESS

PRODUCT DIMENSION (LxWxH)	1560x1443x1510 (mm) 61.4x56.8x59.4 (in)
PRODUCT WEIGHT	137.4kg/302.3lbs

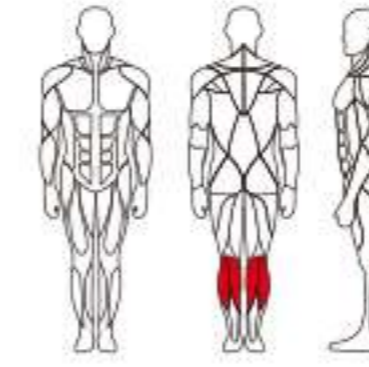

IT9516 CALF RAISE

PRODUCT DIMENSION (LxWxH)	1287x1156x1739 (mm) 50.7x45.5x68.5 (in)
PRODUCT WEIGHT	127.8kg/281.1lbs

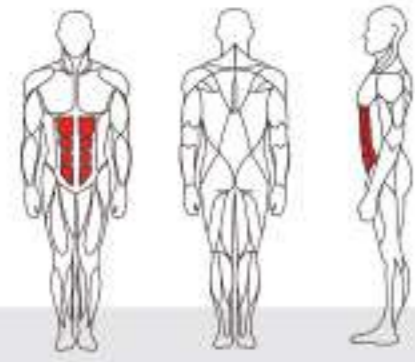

IT9514 ABDOMINAL

PRODUCT DIMENSION (LxWxH)	1345x1148x1581 (mm) 53.0x45.2x62.2 (in)
PRODUCT WEIGHT	112.6kg/247.7lbs

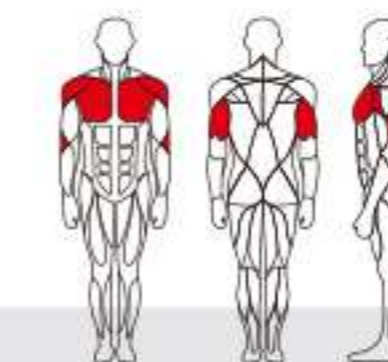

IT9517 SEATED DIP

PRODUCT DIMENSION (LxWxH)	1794x1267x1507 (mm) 70.6x49.9x59.3 (in)
PRODUCT WEIGHT	142.5kg/313.5lbs

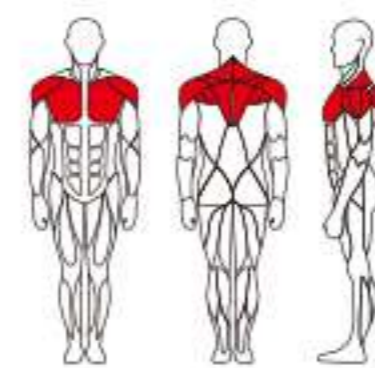

IT9515 PEC FLY/REAR DELT

PRODUCT DIMENSION (LxWxH)	1275x1288x2048 (mm) 50.2x50.7x80.6 (in)
PRODUCT WEIGHT	123.5kg/271.7lbs

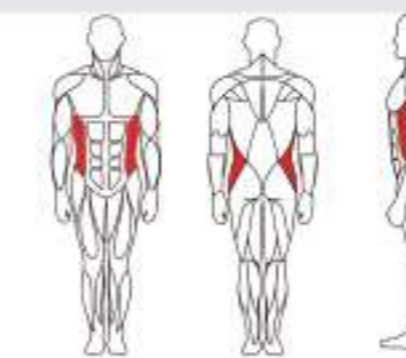

IT9518 TORSO ROTATION

PRODUCT DIMENSION (LxWxH)	1221x1202x1506 (mm) 48.1x47.3x59.3 (in)
PRODUCT WEIGHT	150.8kg/331.8lbs



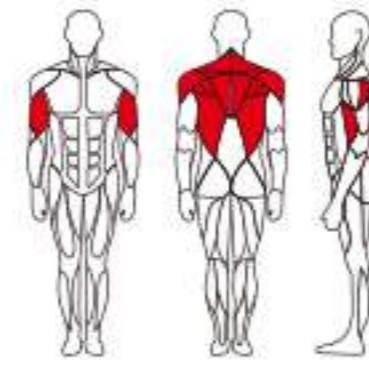

IT9519 VERTICAL ROW

PRODUCT DIMENSION (LxWxH)	1617x1264x1508(mm) 63.7x49.8x59.4 (in)
PRODUCT WEIGHT	126.5kg/278.3lbs

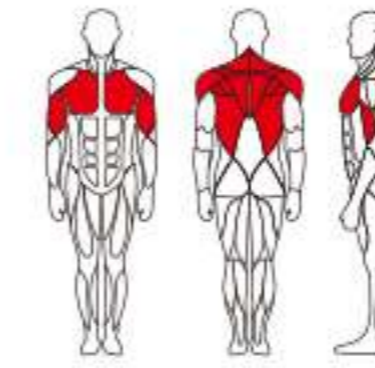

IT9522 LAT PULLDOWN/VERTICAL ROW

PRODUCT DIMENSION (LxWxH)	1897x1223x2228(mm) 74.7x48.1x87.7 (in)
PRODUCT WEIGHT	118.5kg/260.7lbs

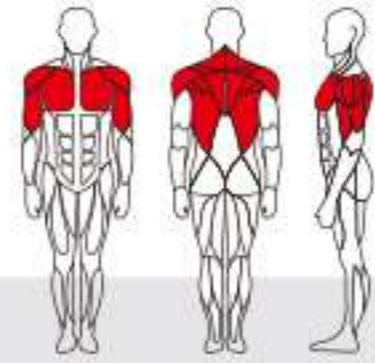

IT9520 WEIGHT ASSISTED CHIN/DIP COMBO

PRODUCT DIMENSION (LxWxH)	1570x1394x2286(mm) 61.8x54.9x90.0 (in)
PRODUCT WEIGHT	125.5kg/276.1lbs

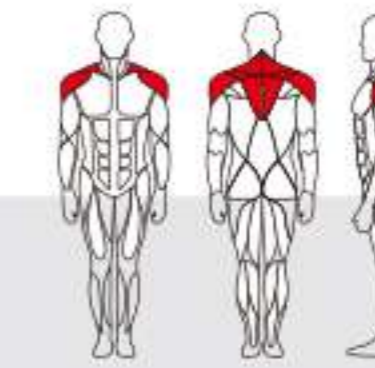

IT9524 LATERAL RAISE

PRODUCT DIMENSION (LxWxH)	1222x1213x1506 (mm) 48.1x47.8x59.3 (in)
PRODUCT WEIGHT	127.5kg/280.5lbs

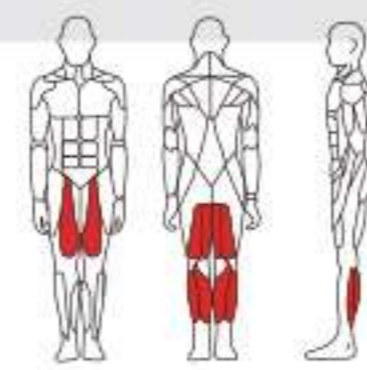

IT9521 PRONE LEG CURL

PRODUCT DIMENSION (LxWxH)	1443x1146x1508(mm) 56.8x45.1x59.4 (in)
PRODUCT WEIGHT	129.6kg/285.1lbs

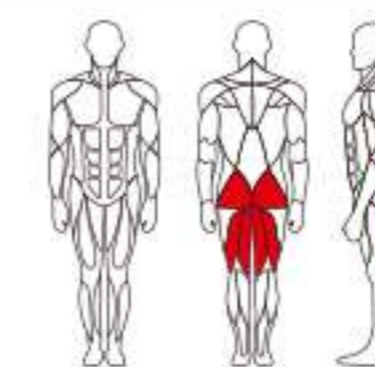

IT9526 GLUTE

PRODUCT DIMENSION (LxWxH)	1503x1245x1508 (mm) 59.2x49x59.4 (in)
PRODUCT WEIGHT	125.5kg/276.1lbs



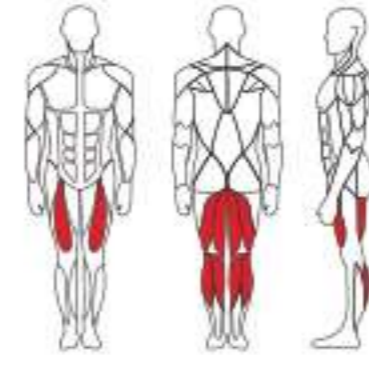

IT9528 LEG EXTENSION/LEG CURL

PRODUCT DIMENSION (LxWxH)	1550x1250x1506 (mm) 61.0x49.2x59.3 (in)
PRODUCT WEIGHT	167Kg/368.2lbs

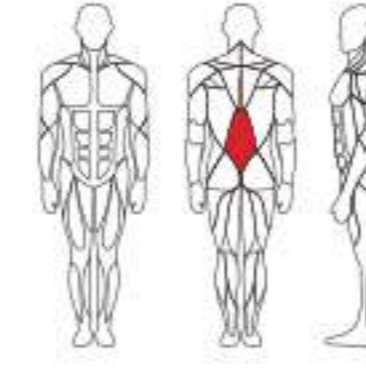

IT9532 BACK EXTENSION

PRODUCT DIMENSION (LxWxH)	1233x1188x1506 (mm) 48.5x56.8x59.3 (in)
PRODUCT WEIGHT	118.5kg/260.7lbs

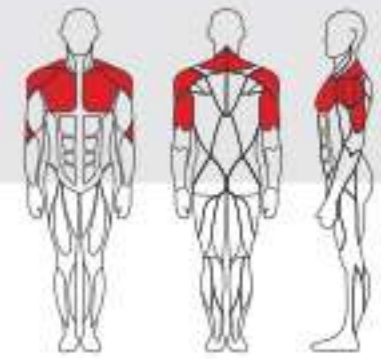

IT9529 MULTI PRESS

PRODUCT DIMENSION (LxWxH)	1827x1437x1669 (mm) 71.9x56.6x65.7 (in)
PRODUCT WEIGHT	166kg/365.9lbs

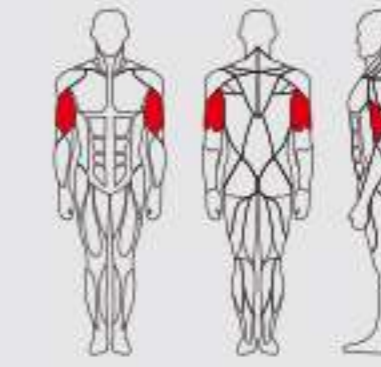

IT9533 BICEP CURL/TRICEP EXTENSION

PRODUCT DIMENSION (LxWxH)	1300x1225x1502(mm) 51.2x48.2x59.1(in)
PRODUCT WEIGHT	132.5kg/291.5lbs



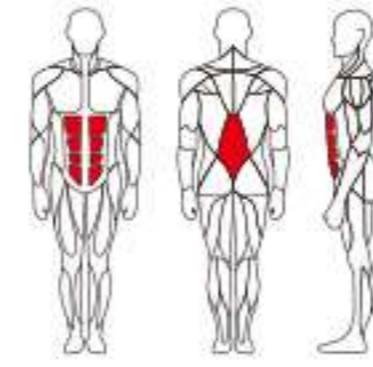

IT9534 ABDOMINAL/BACK EXTENSION

PRODUCT DIMENSION (LxWxH)	1196x1189x1506(mm) 53.4x50.8x61.7(in)
PRODUCT WEIGHT	139.2kg/306.2lbs

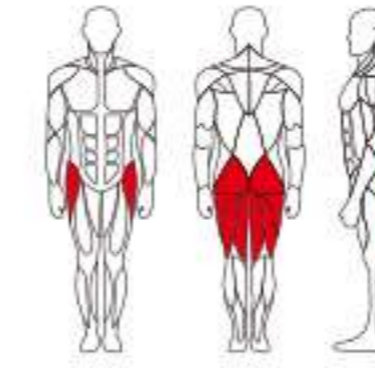

IT9538 HIP THRUST

PRODUCT DIMENSION (LxWxH)	1563x1290x1506(mm) 61.5x50.8x59.3(in)
PRODUCT WEIGHT	255kg/562.2lbs

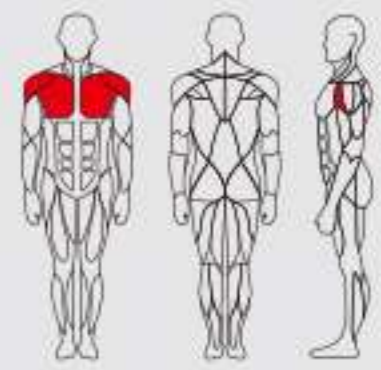

IT9537 STANDING MULTI FLIGHT MACHINE

PRODUCT DIMENSION (LxWxH)	1455x906x1863(mm) 57.3x35.7x73.3(in)
PRODUCT WEIGHT	270kg/595.2lbs

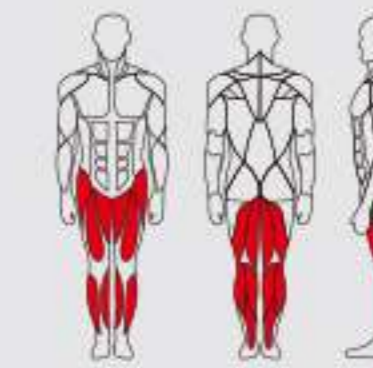

IT9539 SEATED LEG PRESS HACK SQUAT

PRODUCT DIMENSION (LxWxH)	1857x1090x1506(mm) 73.1x42.9x59.3(in)
PRODUCT WEIGHT	325kg/716.5lbs



* COLOR OPTIONAL



IT9501 CHEST PRESS IT9502 LAT PULLDOWN IT9503 ARM CURL IT9504 PECTORAL IT9505 LEG EXTENSION



IT9519 VERTICAL ROW IT9520 WEIGHT ASSISTED CHIN/DIP COMBO IT9521 PRONE LEG CURL IT9522 LAT PULLDOWN VERTICAL ROW IT9524 LATERAL RAISE



IT9506 SEATED LEG CURL IT9508 ABDUCTOR/ADDUCTOR IT9509 TOTAL HIP IT9510 LEG PRESS IT9512 SHOULDER PRESS



IT9526 GLUTE IT9528 LEG EXTENSION/LEG CURL IT9529 MULTI PRESS IT9532 BACK EXTENSION IT9533 BICEP CURL TRICEP EXTENSION



IT9514 ABDOMINAL IT9515 PEC FLY/REAR DELT IT9516 CALF RAISE IT9517 SEATED DIP IT9518 TORSO ROTATION



IT9534 ABDOMINAL BACK EXTENSION IT9537 STANDING MULTI FLIGHT MACHINE IT9538 HIP THRUST IT9539 SEATED LEG PRESS HACK SQUAT

IF93 >>>

These simple, clean-lines, selectorized series specially designed for entry level small clubs and institutional applications. It offers a complete functional package, is inexpensive to own and is easy to maintain. It matches up beautifully with the benches and racks of the IF line.



- The clear and precise instructions and training tips are great for individuals who is new to strength training and help users to build targeted muscle .
- Specially designed cup holder is perfectly integrated with cage, making it simple and enerosus.
- The upright tubing thickness of 2.5mm and the functional parts with rectangular tube at size of 50×100×2.5mm, which make IF93 stronger and more powerful.
- The translucent shroud with ABS materials (optional full shroud) is enduring and wear resisting. The main plastic parts are made using injection molding that help to provide teady quality.
- The whole series are adopted with the equivalent cage height of 1530mm, which help to create a bright training environment of fitness club.
- Ergonomic seat cushion, chest and back pad are made of polymer materials. The specially designed pads have different angles, which meet various training requirements.
- Ergonomically designed handle bars are made of TPV materials, which make your garb more comfortable and safety. It combines with aluminum end cap reflecting high-end taste.
- The main frame is coated with materials that environmental friendly, which helps to improve products quality and provide with good scratching and corrosion resistance.
- Designed with stainless steel seat adjustment that provides a longer service life, made it easy to adjust and look beautiful.
- All pulleys are adopted with high quality bearings which ensure smooth movement.

* WEIGHT STACK SOLD SEPARATELY

OPTION 1	160lbs/68.3kg
OPTION 2	200lbs/85.5kg
OPTION 3	235lbs/102.8kg
OPTION 4	295lbs/129.2kg



* THE FULL SHROUD IS OPTIONAL.
(Weight stacks varies by the shrouds)



IF9301 CHEST PRESS

PRODUCT DIMENSION (L×W×H)	1040×1360×1530 (mm) 40.5×53.5×60.2 (in)
PRODUCT WEIGHT	97.1kg



IF9302 LAT PULLDOWN

PRODUCT DIMENSION (L×W×H)	1585×1318×1891 (mm) 42.4×51.9×74.4 (in)
PRODUCT WEIGHT	100kg



IF9305 LEG EXTENSION

PRODUCT DIMENSION (L×W×H)	1146×1050×1530 (mm) 45.1×41.3×60.2 (in)
PRODUCT WEIGHT	101.5kg



IF9306 SEATED LEG CURL

PRODUCT DIMENSION (L×W×H)	1148×1034×1530 (mm) 45.2×40.7×60.2 (in)
PRODUCT WEIGHT	95kg



IF9303 ARM CURL

PRODUCT DIMENSION (L×W×H)	1216×1028×1530 (mm) 47.9×40.5×60.2 (in)
PRODUCT WEIGHT	90kg



IF9304 PECTORAL

PRODUCT DIMENSION (L×W×H)	1736×806×1530 (mm) 68.3×31.7×60.2 (in)
PRODUCT WEIGHT	95kg

* The right of specific weight to actual supply prevail.



IF9308 ABDUCTOR/ADDUCTOR

PRODUCT DIMENSION (L×W×H)	1570×935×1530 (mm) 61.8×36.8×60.2 (in)
PRODUCT WEIGHT	98.5kg



IF9310 LEG PRESS

PRODUCT DIMENSION (L×W×H)	1790×1168×1530 (mm) 70.5×46.0×60.2(in)
PRODUCT WEIGHT	120.5kg



IF9312 SHOULDER PRESS

PRODUCT DIMENSION (L×W×H)	1149×1456×1530 (mm) 45.2×57.3×60.2 (in)
PRODUCT WEIGHT	102.6kg



IF9315 PEC FLY/REAR DELT

PRODUCT DIMENSION (L×W×H)	1420×1493×1863 (mm) 58.8×55.9×73.3 (in)
PRODUCT WEIGHT	90kg



IF9316 CALF RAISE

PRODUCT DIMENSION (L×W×H)	1150×1105×1775 (mm) 45.3×43.5×69.9(in)
PRODUCT WEIGHT	106kg



IF9314 ABDOMINAL

PRODUCT DIMENSION (L×W×H)	1304×1484×1490 (mm) 51.3×58.4×58.7 (in)
PRODUCT WEIGHT	89.5kg



IF9317 SEATED DIP

PRODUCT DIMENSION (L×W×H)	1227×1212×1530 (mm) 48.3×47.7×60.2(in)
PRODUCT WEIGHT	97.5kg



IF9318 TORSO ROTATION

PRODUCT DIMENSION (L×W×H)	1240×1105×1530 (mm) 48.8×43.5×60.2(in)
PRODUCT WEIGHT	96kg



IF9319 VERTICAL ROW

PRODUCT DIMENSION (L×W×H)	1818×870×1530 (mm) 71.6×34.3×60.2(in)
PRODUCT WEIGHT	91.5kg



IF9321 PRONE LEG CURL

PRODUCT DIMENSION (L×W×H)	1510×1150×1530 (mm) 59.4×45.3×60.2(in)
PRODUCT WEIGHT	101.5kg

IF9320
WEIGHT ASSISTED CHIN/DIP COMBO

PRODUCT DIMENSION (L×W×H)	1309×1256×2498 (mm) 51.5×49.4×98.3(in)
PRODUCT WEIGHT	107kg

IF9322
LAT PULLDOWN/VERTICAL ROW

PRODUCT DIMENSION (L×W×H)	1886×1223×2227 (mm) 74.2×48.1×87.7(in)
PRODUCT WEIGHT	90kg



IF9323 ARM EXTENSION

PRODUCT DIMENSION (L×W×H)	1079×1028×1530 (mm) 42.1×40.5×60.2 (in)
PRODUCT WEIGHT	91kg



IF9324 LATERAL RAISE

PRODUCT DIMENSION (L×W×H)	1179×750×1530 (mm) 46.4×29.5×60.2(in)
PRODUCT WEIGHT	85kg



IF9326 KICK BACK

PRODUCT DIMENSION (L×W×H)	1068×1034×1530 (mm) 42.0×40.7×60.2 (in)
PRODUCT WEIGHT	90kg



IF9328 LEG EXTENSION/LEG CURL

PRODUCT DIMENSION (L×W×H)	1272×1270×1530 (mm) 50.1×50.0×60.2 (in)
PRODUCT WEIGHT	105kg



IF9329 MULTI PRESS

PRODUCT DIMENSION (L×W×H)	2026×1446×1530 (mm) 79.8×56.9×60.2(in)
PRODUCT WEIGHT	97.5kg

IF9333
BICEP CURL/TRICEP EXTENSION

PRODUCT DIMENSION (L×W×H)	1327×1203×1530 (mm) 52.2×47.4×60.2(in)
PRODUCT WEIGHT	110kg



IF9334 AB/BACK

PRODUCT DIMENSION (L×W×H)	1592×1253×1531 (mm) 62.7×49.3×60.3(in)
PRODUCT WEIGHT	TBD



IF9332 BACK EXTENSION

PRODUCT DIMENSION (L×W×H)	1120×1034×1530 (mm) 44.0×40.7×60.2 (in)
PRODUCT WEIGHT	98kg



IF9335 ABDUCTOR

PRODUCT DIMENSION (L×W×H)	1583×946×1530 (mm) 62.3×37.2×60.2(in)
PRODUCT WEIGHT	95kg



IF9336 ADDUCTOR

PRODUCT DIMENSION (L×W×H)	1583×1036×1530 (mm) 62.3×40.8×60.2(in)
PRODUCT WEIGHT	95kg



PL Line >>>

Easy to use, neat appearance, the PL line is a high quality dual/multi functional machines Light commercial/commercial series. This PL line is Impulse dual/multi functional line. The user-friendly design makes working out more simple, efficient, comfortable and satisfying.

Instructive - simple, step-by-step instructions and training tips help users get the most out of their exercise.

Aircraft spec 5mm American LOOS cable with a 2,000 lb breaking strength. End fittings tested to 250,000 cycles using full weight stack.

Easy-to-use, minimal adjustments and pre-stretch features allow for optimal exercise positions.

Glass fiber reinforced nylon pulleys with deep V-groove provides secure cable seating and fluid bearing rotation.

Compact - space efficient design requires minimal floor space.

Shroud is applied to protect the equipment or the possible injury during operation.

Tubing: 2.5 mm to 2.75mm. square tube differ into any types, from 30x60mm to 50x100mm, electro-welded to maximum integrity.

Pad total thickness is 70mm.



* WEIGHT STACK SOLD SEPARATELY

OPTION 1	170lbs/70.4kg
OPTION 2	250lbs/102.4kg

Color: metallic silver gray(Other colors are optional based on customer requirements)



PL9002
LAT PULLDOWN/SEATED ROW

PRODUCT DIMENSION (L×W×H)	1764×1019×2182 (mm) 69.4×40.1×85.9 (in)
PRODUCT WEIGHT	90.5 kg / 200 lbs
40'	136 Sets



PL9010
LEG PRESS/CALF RAISE

PRODUCT DIMENSION (L×W×H)	1938×1148×1520 (mm) 76.3×45.2×59.8 (in)
PRODUCT WEIGHT	111 kg / 245 lbs
40'	88 Sets



PL9021 MULTI PRESS

PRODUCT DIMENSION (L×W×H)	1924×1325×1518 (mm) 75.7×52.2×59.8 (in)
PRODUCT WEIGHT	111.5 kg / 246 lbs
40'	120 Sets



PL9022
REAR DELTOID/PECTORAL FLY

PRODUCT DIMENSION (L×W×H)	1362×1219×2061 (mm) 53.6×48.0×81.1 (in)
PRODUCT WEIGHT	107 kg / 236 lbs
40'	124 Sets



PL9016
OUTER/INNER THIGH

PRODUCT DIMENSION (L×W×H)	1609×722×1515 (mm) 63.3×28.4×59.6 (in)
PRODUCT WEIGHT	99 kg / 218 lbs
40'	130 Sets



PL9019
LEG EXTENSION/LEG CURL

PRODUCT DIMENSION (L×W×H)	1465×1245×1520 (mm) 57.7×49×59.8 (in)
PRODUCT WEIGHT	115.5 kg / 255 lbs
40'	75 Sets



PL9023 BICEPS/TRICEPS

PRODUCT DIMENSION (L×W×H)	1207×1164×1513 (mm) 47.5×45.8×59.6 (in)
PRODUCT WEIGHT	106 kg / 234 lbs
40'	115 Sets



PL9024 AB/LOW BACK

PRODUCT DIMENSION (L×W×H)	1044×1094×1520 (mm) 41.1×43.1×59.8 (in)
PRODUCT WEIGHT	99.5 kg / 219 lbs
40'	135 Sets

Jungle >> >



Larger distance between left and right upright accomodates a variety of users needs. No interference for users during exercise. (distance between sliding rail is 2680mm)

Perfect training placard enable detailed and professional guide to workout

Assistance handle bar: Easy hand grips help user keeping balance in exercise and enable more strength training.

Use 3.0mm thickness tube and spray powder coated. It has enhanced corrosion resistance and better appearance.

Latch adjustment structure ensures smooth and safe adjustment

The height of groundpads are adjustable which guarantees the stabilization of machine.

Multi-handle grips accomodate a variety of user training demands

Thanks to 1785mm sliderail, the hand grips could be adjusted from 1 to 36 degree. It helps to train almost total body muscle groups.

Use stainless steel roller tubing that prevent machine from wearing and corrosion.

Larger size of groundtubing strengthen stablization of machine

Multiple accessory racks enable user to put stuff and easy of access.

Shroud is made of translucent injection molding ABS which make the machine safer and good-looking.

Use dual-pulley for high rowing and low rowing. Increase diversity of motion.

Switch from high rowing to low rowing which accomodates different sizes of training field yet saving space either.

* WEIGHT STACK SOLD SEPARATELY

OPTION 1	160lbs/68.3kg
OPTION 2	200lbs/85.5kg
OPTION 3	235lbs/102.8kg
OPTION 4	295lbs/129.2kg



* COLOR OPTIONAL.
OPTIONAL FULL OR SMALL SHROUD.



IT9525 ADJUSTABLE HI/LO PULLEY

PRODUCT DIMENSION (LxWxH)	1450x1245x2350(mm) 57.1x49.0x92.5(in)
PRODUCT WEIGHT	137.5kg/303.1lbs



IT9527 4 STACK MULTI-STATION

PRODUCT DIMENSION (LxWxH)	3489x1968x2382(mm) 137.4x77.5x93.8(in)
PRODUCT WEIGHT	308.7kg/680.6lbs



IT9530 DUAL ADJUSTABLE PULLEY

PRODUCT DIMENSION (LxWxH)	1620x1370x2270(mm) 63.8x53.9x89.4(in)
PRODUCT WEIGHT	195.5kg/431lbs



IT9527OPT CABLE CROSSOVER-TRADITIONAL

PRODUCT DIMENSION (LxWxH)	2824x222x483(mm) 111.2x8.74x19.0(in)
PRODUCT WEIGHT	27.5kg/60.6lbs



IT9525+IT9525+IT9527OPT

PRODUCT DIMENSION (LxWxH)	4196 × 1436 × 2360(mm) 165.2 × 56.5 × 92.9(in)
------------------------------	---

IT9525+IT9527+IT9527OPT

PRODUCT DIMENSION (LxWxH)	5089 × 3489 × 2380(mm) 200.4 × 137.4 × 93.7(in)
------------------------------	--



IT9527+IT9527+IT9527OPT

PRODUCT DIMENSION (LxWxH)	5982 × 3489 × 2380(mm) 235.5 × 137.4 × 93.7(in)
------------------------------	--

COLOR OPTIONAL



IT9525 ADJUSTABLE HI/LO PULLEY



IT9527 4 STACK MULTI-STATION



IT9525+IT9525+IT9527OPT



IT9525+IT9527+IT9527OPT



IT9530 DUAL ADJUSTABLE PULLEY



IT9527OPT CABLE CROSSOVER-TRADITIONAL



IT9527+IT9527+IT9527OPT



SL9525
ADJUSTABLE HI/LO PULLEY

PRODUCT DIMENSION (LxWxH)	1482x1187x2356 (mm) 58.3x46.7x92.8 (in)
PRODUCT WEIGHT	134.2kg/295.9lbs



SL9527 JUNGLE MULTI GYM

PRODUCT DIMENSION (LxWxH)	3488x2646x2350 (mm) 137.3x104.2x92.5 (in)
PRODUCT WEIGHT	386.4kg/851.9lbs



IT9527OPT
CABLE CROSSOVER-TRADITIONAL

PRODUCT DIMENSION (LxWxH)	2824x221x477 (mm) 111.2x8.7x18.8 (in)
PRODUCT WEIGHT	27.3kg/60.2lbs



SL9525+SJ9525+SL9527OPT

PRODUCT DIMENSION (LxWxH)	4249x1482x2365 (mm) 167.3x58.3x93.1 (in)
---------------------------	---

SL9525+SL9527+SL9527OPT

PRODUCT DIMENSION (LxWxH)	5824x3488x2365 (mm) 229.3x137.3x93.1 (in)
---------------------------	--



SL9527+SL9527+SL9527OPT

PRODUCT DIMENSION (LxWxH)	7380x4377x2365 (mm) 290.6x172.3x93.1 (in)
---------------------------	--



IF9325 ADJUSTABLE HI / LO PULLEY

PRODUCT DIMENSION (L×W×H)	1449×1258×2338 (mm) 57.0×49.5×92.0 (in)
PRODUCT WEIGHT 40'	96 kg / 212 lbs 108 Sets



IF9330 DUAL ADJUSTABLE PULLEY

PRODUCT DIMENSION (L×W×H)	1639×882×2270 (mm) 64.5×34.7×89.4(in)
PRODUCT WEIGHT	117kg



IF9327 4 STACK MULTI-STATION

PRODUCT DIMENSION (L×W×H)	3450×2445×2338 (mm) 135.8×96.3×92.0 (in)
PRODUCT WEIGHT 40'	258.6 kg / 570 lbs 48 Sets



IF9327OPT CABLE CROSSOVER-TRADITIONAL

PRODUCT DIMENSION (L×W×H)	2505×441×198 (mm) 98.6×17.4×7.8 (in)
PRODUCT WEIGHT 40'	21.5 kg / 47 lbs 526 Sets

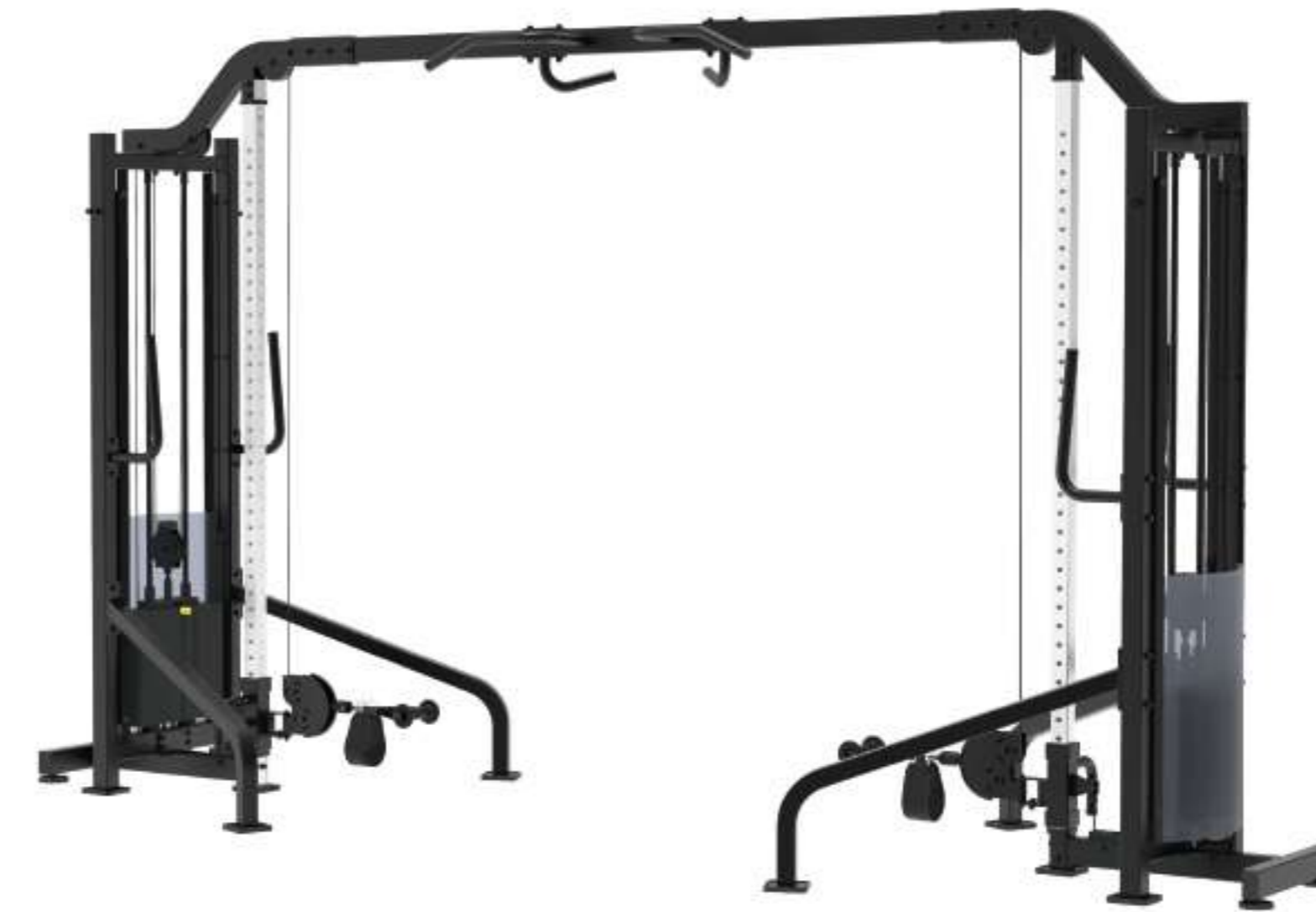

CABLE CROSSOVER IF9325+IF9325+IF9327OPT

PRODUCT DIMENSION (L×W×H)	4138x1448x2355(mm) 162.9x57.0x92.7(in)
------------------------------	---

5 STACK MULTI-STATION IF9325+IF9327+IF9327OPT

PRODUCT DIMENSION (L×W×H)	5220x3428x2355(mm) 205.5x135.0x92.7(in)
------------------------------	--

• OPTIONAL FULL SHROUD VERSION.



8 STACK MULTI-STATION IF9327+IF9327+IF9327OPT

PRODUCT DIMENSION (L×W×H)	6262x3428x2355(mm) 246.5x135.0x92.7(in)
------------------------------	--



ECP Line >>>

Impulse Fitness proudly presents the EVOLUTION CURVE Series, a groundbreaking line of plate-loaded strength machines. Incorporating a linkage-adjustable force structure in most models, these machines are tailored to match the strength curve characteristics of specific muscle groups, ensuring user comfort, training efficiency, and safety throughout the workout. Named the EVOLUTION CURVE PLATE-LOADED STRENGTH SERIES, or simply the ECP series, it promises an exceptional training experience.



The main components of the entire series consist of trapezoidal, triangular, and rectangular tubes.



linkage structure is adopted.



Ergonomic aluminum grips with marked scales.

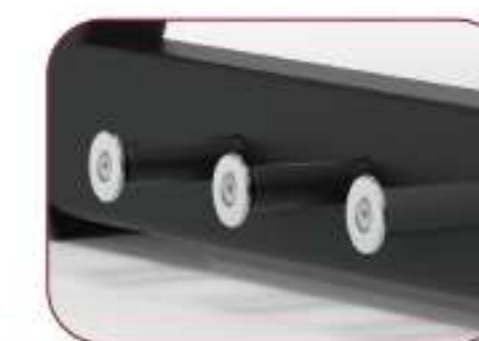

Each product is equipped with elastic band attachment points and storage slots.



Utilizing PU seat cushions.

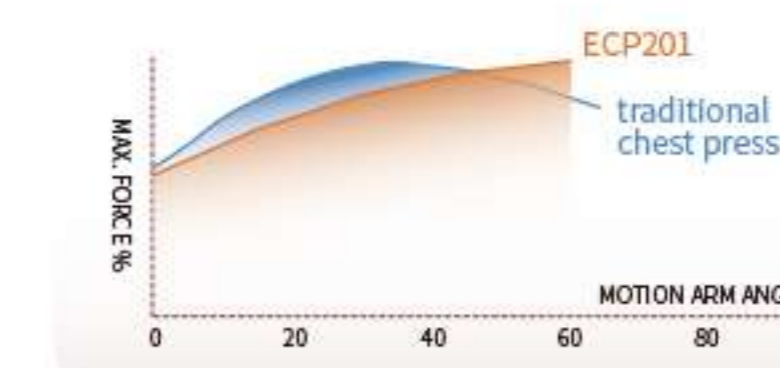

Force Curve Comparison Chart

Compared to traditional plate-loaded equipment, the ECP series offers smoother force lines from the initial lift, ensuring that there is no loss of force toward the end of the movement.



ECP101 SHOULDER PRESS

PRODUCT DIMENSION (L×W×H)	1638×1515×1455 (mm) 64.5×59.6×57.3 (in)
PRODUCT WEIGHT	215 kg/474.0 lbs
MAX. WEIGHT CAPACITY	200 kg/440.9 lbs



ECP201 CHEST PRESS

PRODUCT DIMENSION (L×W×H)	1800×1750×1800 (mm) 70.9×68.9×70.9 (in)
PRODUCT WEIGHT	265 kg/584.2 lbs
MAX. WEIGHT CAPACITY	200 kg/440.9 lbs

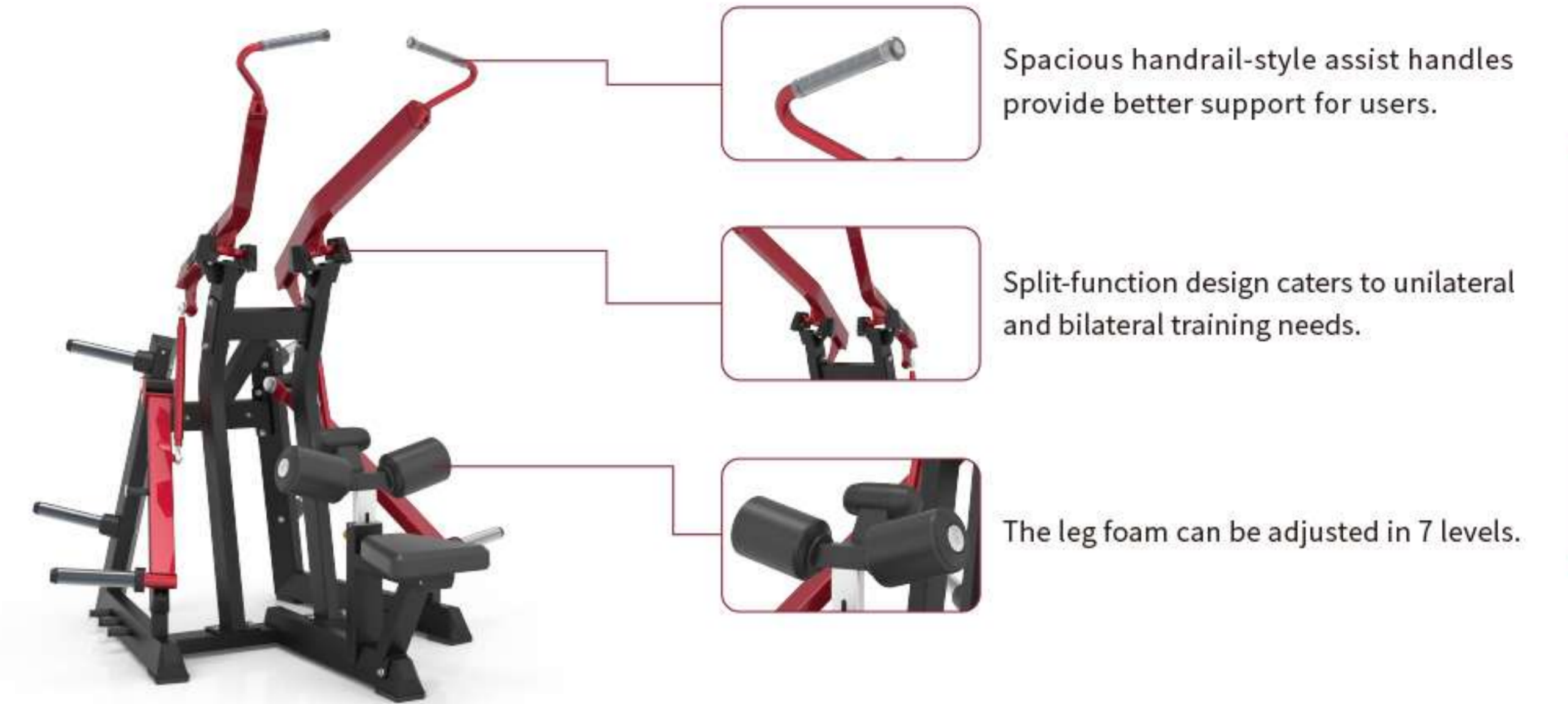

ECP301 PULLDOWN

PRODUCT DIMENSION (L×W×H)	1745×1645×1932 (mm) 68.7×64.8×76.1 (in)
PRODUCT WEIGHT	210 kg/463.0 lbs
MAX. WEIGHT CAPACITY	200 kg/440.9 lbs



ECP302 SEATED ROW

PRODUCT DIMENSION (L×W×H)	1600×1800×1100 (mm) 63.0×70.9×43.3 (in)
PRODUCT WEIGHT	190 kg/418.9 lbs
MAX. WEIGHT CAPACITY	120 kg/264.6 lbs



Dual-purpose design with both shoulder and waist carrying options.

Adjustable foot pedal angle with 4 levels from 35° to 50°.

Adjustable safety limit to effectively protect users.

ECP617 HACK SQUAT

PRODUCT DIMENSION (L×W×H)	2185×1290×1416 (mm) 86.0×50.8×55.7 (in)
PRODUCT WEIGHT	315 kg/694.5 lbs
MAX. WEIGHT CAPACITY	400 kg/881.8 lbs



Convenient dual-sided handle adjustments.

Balance weight added.

Adjustable foot pedal angle with six settings and a spacious platform (750*665).

ECP713 SQUAT

PRODUCT DIMENSION (L×W×H)	2300×1260×1790 (mm) 90.6×49.6×70.5 (in)
PRODUCT WEIGHT	330 kg/727.5 lbs
MAX. WEIGHT CAPACITY	400 kg/881.8 lbs



COLOR OPTIONAL



ECP101 SHOULDER PRESS



ECP201 CHEST PRESS



ECP617 HACK SQUAT



ECP713 SQUAT



ECP301 PULLDOWN



ECP302 SEATED ROW





SL Line >>>

Easy to use, neat appearance, the SL line is a high quality commercial plate loaded series. The user-friendly design makes working out more simple, efficient, comfortable and satisfying.

Tubing: thickness range from 2.5 mm to 3mm, 50mmx100mm tubing, electro-welded to maximum integrity.

Color: black and red (Other colors are optional based on customer requirements)

Finish: Electrostatic powder-coated and heat cured after adhesiveness enhancement pre-treatment for superior durability



Compact - space efficient design requires minimal floor space.

Pad total thickness is 70mm.

Easy-to-use, flexible adjustments allow for optimal exercise positions.



* COLOR OPTIONAL



SL7001 CHEST PRESS

PRODUCT DIMENSION (L×W×H)	1937×1370×1717 (mm) 76.3×53.9×67.6 (in)
PRODUCT WEIGHT	170.5 kg / 375.9 lbs
40'	70 Sets
MAX. WEIGHT CAPACITY	300 Kg / 660 lbs



SL7002 PULLDOWN

PRODUCT DIMENSION (L×W×H)	1482×1489×1967 (mm) 58.3×58.6×77.4 (in)
PRODUCT WEIGHT	169 kg / 372.6 lbs
40'	81 Sets
MAX. WEIGHT CAPACITY	300 kg / 660 lbs



SL7005 INCLINE CHEST PRESS

PRODUCT DIMENSION (L×W×H)	1900×1523×1779 (mm) 74.8×60×70 (in)
PRODUCT WEIGHT	184 kg / 405.7 lbs
40'	72 Sets
MAX. WEIGHT CAPACITY	300 kg / 660 lbs



SL7006 LEG PRESS

PRODUCT DIMENSION (L×W×H)	2226×1421×1415 (mm) 87.6×55.9×55.7 (in)
PRODUCT WEIGHT	195 kg / 429.9 lbs
40'	65 Sets
MAX. WEIGHT CAPACITY	400 kg / 880 lbs



SL7003 SHOULDER PRESS

PRODUCT DIMENSION (L×W×H)	1558×1818×1487 (mm) 61.3×71.6×58.5 (in)
PRODUCT WEIGHT	171.5 kg / 378.1 lbs
40'	89 Sets
MAX. WEIGHT CAPACITY	300 kg / 660 lbs



SL7004 LOW ROW

PRODUCT DIMENSION (L×W×H)	1761×1458×1650 (mm) 69.3×57.4×65 (in)
PRODUCT WEIGHT	170 kg / 374.8 lbs
40'	69 Sets
MAX. WEIGHT CAPACITY	300 kg / 660 lbs



SL7007 ROW

PRODUCT DIMENSION (L×W×H)	1815×1500×1334 (mm) 71.5×59.1×52.5 (in)
PRODUCT WEIGHT	160 kg / 352.7 lbs
40'	87 Sets
MAX. WEIGHT CAPACITY	300 kg / 660 lbs



SL7008 REAR KICK

PRODUCT DIMENSION (L×W×H)	1680×1229×1636 (mm) 66.1×48.4×64.4 (in)
PRODUCT WEIGHT	144 kg / 317.5 lbs
40'	82 Sets
MAX. WEIGHT CAPACITY	150kg / 330lbs



SL7013 GLUTE HAM BENCH

PRODUCT DIMENSION (L×W×H)	1562×914×1477 (mm) 61.5×36×58.1 (in)
PRODUCT WEIGHT	70 kg / 154 lbs
40'	105 Sets



SL7017 SEATED CALF RAISE

PRODUCT DIMENSION (L×W×H)	1475×765×845 (mm) 58×30.1×33.3 (in)
PRODUCT WEIGHT	56 kg / 123 lbs
40'	174 Sets
MAX. WEIGHT CAPACITY	150 kg / 330 lbs



SL7019 INCLINE ROW

PRODUCT DIMENSION (L×W×H)	1960×1020×1253 (mm) 77.2×40.2×49.3 (in)
PRODUCT WEIGHT	89 kg / 196 lbs
40'	97 Sets
MAX. WEIGHT CAPACITY	150 kg / 330 lbs



SL7021 HACK SQUAT

PRODUCT DIMENSION (L×W×H)	2205×1880×1285 (mm) 86.8×74×50.6 (in)
PRODUCT WEIGHT	235.5 kg / 519.2 lbs
MAX. WEIGHT CAPACITY	400 kg / 880 lbs



SL7020 45 LEG PRESS

PRODUCT DIMENSION (L×W×H)	2499×1879×1544 (mm) 98.4×74×60.8 (in)
PRODUCT WEIGHT	249kg / 548lbs
40'	58 Sets
MAX. WEIGHT CAPACITY	450kg / 990lbs





SL7023 BICEP CURL

PRODUCT DIMENSION (L×W×H)	1492×1045×1204 (mm) 58.7×41.1×47.4 (in)
PRODUCT WEIGHT	114 kg / 251.3 lbs
40°	96 Sets
MAX. WEIGHT CAPACITY	120 kg / 264 lbs



SL7024 TRICEP DIP

PRODUCT DIMENSION (L×W×H)	1733×1580×1202 (mm) 68.2×62.2×47.3 (in)
PRODUCT WEIGHT	166.3 kg / 366.6 lbs
MAX. WEIGHT CAPACITY	300 kg / 660 lbs



SL7032 STANDING CALF RAISE

PRODUCT DIMENSION (L×W×H)	1615×1375×1730(mm) 63.6×54.1×68.1 (in)
PRODUCT WEIGHT	146.2 kg/322.3 lbs
MAX. WEIGHT CAPACITY	300 kg/660 lbs



SL7034 SQUAT

PRODUCT DIMENSION (L×W×H)	2260x1260x1800 (mm) 88.9x49.6x70.9 (in)
PRODUCT WEIGHT	212 kg/467.4 lbs
MAX. WEIGHT CAPACITY	400 kg/880 lbs



SL7025 LEG EXTENSION

PRODUCT DIMENSION (L×W×H)	1270×1690×1005 (mm) 50×66.5×39.6 (in)
PRODUCT WEIGHT	130.9 kg / 288.6 lbs
MAX. WEIGHT CAPACITY	300 kg / 660 lbs



SL7026 LEG CURL

PRODUCT DIMENSION (L×W×H)	1430×1045×1200 (mm) 56.3×41.1×47.2 (in)
PRODUCT WEIGHT	141.1 kg / 311.1 lbs
MAX. WEIGHT CAPACITY	120 kg / 264 lbs



SL7036 ABDOMINAL

PRODUCT DIMENSION (L×W×H)	1623×1267×1642 (mm) 63.9×49.9×64.6 (in)
PRODUCT WEIGHT	132 kg/291 lbs
MAX. WEIGHT CAPACITY	120 kg/264 lbs





SL7038 TOTAL HIP

PRODUCT DIMENSION (L×W×H)	1620×1610×1110 (mm) 63.8×63.4×43.7 (in)
PRODUCT WEIGHT	114.7 kg/253 lbs
MAX. WEIGHT CAPACITY	150 kg/331 lbs



SL7039 STANDING PRESS

PRODUCT DIMENSION (L×W×H)	2170×2000×2135 (mm) 85.4×78.7×84.1 (in)
PRODUCT WEIGHT	181.4 kg/399.9 lbs
MAX. WEIGHT CAPACITY	300 kg/661 lbs



SL7028 FLAT BENCH PRESS

PRODUCT DIMENSION (L×W×H)	1910x1738x1315 (mm) 75.2x68.4x51.8 (in)
PRODUCT WEIGHT	111 kg/244.7 lbs
MAX. WEIGHT CAPACITY	300 kg/660 lbs



SL7029 INCLINE BENCH PRESS

PRODUCT DIMENSION (L×W×H)	2059x1738x1496 (mm) 81.1x68.4x58.9 (in)
PRODUCT WEIGHT	109 kg/240.3 lbs
MAX. WEIGHT CAPACITY	300 kg/660 lbs



SL7040 SQUAT LUNGE

PRODUCT DIMENSION (L×W×H)	1700×1670×640 (mm) 66.9×65.7×25.2 (in)
PRODUCT WEIGHT	123 kg/271 lbs
MAX. WEIGHT CAPACITY	300 kg/661 lbs



SL7030 DECLINE BENCH PRESS

PRODUCT DIMENSION (L×W×H)	2188x1738x1315 (mm) 86.1x68.4x51.8 (in)
PRODUCT WEIGHT	110.3 kg/243.2 lbs
MAX. WEIGHT CAPACITY	300 kg/660 lbs



SL7031 SHOULDER BENCH PRESS

PRODUCT DIMENSION (L×W×H)	1719x1261x1920(mm) 67.7x49.6x75.6(in)
PRODUCT WEIGHT	146.5 kg/323.0 lbs
MAX. WEIGHT CAPACITY	400 kg/880 lbs



SL7009 POWER RACK

PRODUCT DIMENSION (L×W×H)	2031×1499×2278 (mm) 80×59×89.7 (in)
PRODUCT WEIGHT	200 kg / 441 lbs
40'	82 Sets



SL7009OPT WEIGHT PLATE RACK OPTION

PRODUCT DIMENSION (L×W×H)	1674×717×2199 (mm) 65.9×28.2×86.6 (in)
PRODUCT WEIGHT	63.5 kg / 140 lbs
40'	144 Sets



SL7010 PLATE RACK

PRODUCT DIMENSION (L×W×H)	891×628×1228 (mm) 35.1×24.7×48.3 (in)
PRODUCT WEIGHT	44 kg / 97 lbs
40'	242 Sets



SL7027 BARBELL RACK

PRODUCT DIMENSION (L×W×H)	950×910×1612 (mm) 37.4×35.8×63.5 (in)
PRODUCT WEIGHT	73 kg / 161 lbs
40'	112 Sets



SL7014 HALF POWER RACK

PRODUCT DIMENSION (L×W×H)	1390×1747×2442 (mm) 54.7×68.8×96.1 (in)
PRODUCT WEIGHT	153 kg / 337 lbs
40'	108 Sets



SL7015 FULL POWER RACK

PRODUCT DIMENSION (L×W×H)	1966×1747×2442 (mm) 77.4×68.8×96.1 (in)
PRODUCT WEIGHT	216 kg / 476 lbs
40'	83 Sets

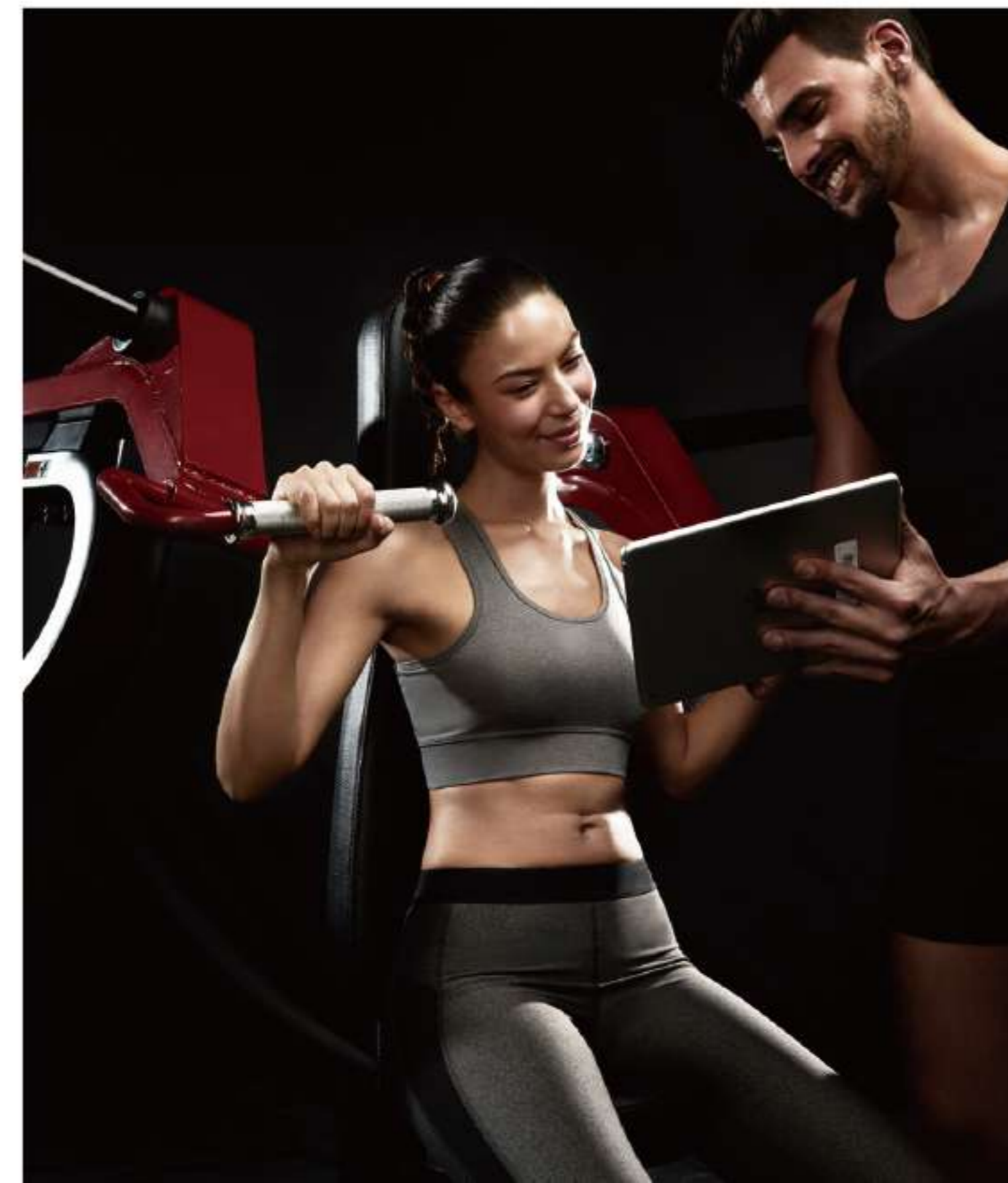

SL7016 DUMBBELL RACK

PRODUCT DIMENSION (L×W×H)	2260×760×740 (mm) 89.0×29.9×29.1 (in)
PRODUCT WEIGHT	75.9 kg/167.3 lbs
40'	240 Sets
MAX. WEIGHT CAPACITY	700 kg/ 1540 lbs



SL7011 FID BENCH

PRODUCT DIMENSION (L×W×H)	1350×670×1350 (mm) 53.1×26.4×53.1 (in)
PRODUCT WEIGHT	44 kg / 97 lbs
40'	252 Sets



SL7012 FID BENCH

PRODUCT DIMENSION (L×W×H)	1550×670×1350 (mm) 61×26.4×53.1 (in)
PRODUCT WEIGHT	47 kg / 104 lbs
40'	252 Sets



SL7041 SUPER OLYMPIC BENCH

PRODUCT DIMENSION (L×W×H)	2410×1743×1622 (mm) 94.9×68.6×63.9 (in)
PRODUCT WEIGHT	141.3 kg/312 lbs
MAX. WEIGHT CAPACITY	300 kg/661 lbs



SL7042 MAGIC RACK/SMITH MACHINE

PRODUCT DIMENSION (L×W×H)	2315×2241×2391 (mm) 91.1×88.2×94.1 (in)
PRODUCT WEIGHT	313.4 kg/690.9 lbs
MAX. WEIGHT CAPACITY	300 kg/661 lbs



SL7018 ARM CURL

PRODUCT DIMENSION (L×W×H)	1136x860x1016 (mm) 44.7x33.9x40.0(in)
PRODUCT WEIGHT	70 kg/154.3 lbs
MAX.WEIGHT CAPACITY	300 kg/661.4 lbs



SL7022 UTILITY BENCH

PRODUCT DIMENSION (L×W×H)	1191×630×822 (mm) 46.9×24.8×32.4 (in)
PRODUCT WEIGHT	27.8 kg / 61.3 lbs
40'	253 Sets



SL7035 FLAT BENCH

PRODUCT DIMENSION (L×W×H)	1281x630x425 (mm) 50.4x24.8x16.7 (in)
PRODUCT WEIGHT	25.3 kg/55.8 lbs
MAX. WEIGHT CAPACITY	300 kg/660 lbs



SL7043 MULTI AB BENCH

PRODUCT DIMENSION (L×W×H)	1722×630×912 (mm) 67.8×24.8×35.9 (in)
PRODUCT WEIGHT	54 kg/119 lbs
MAX. WEIGHT CAPACITY	150 kg/331 lbs



SL7044 STRETCH

PRODUCT DIMENSION (L×W×H)	1567×630×1263 (mm) 61.7×24.8×49.7 (in)
PRODUCT WEIGHT	50 kg/110 lbs
MAX. WEIGHT CAPACITY	150 kg/331 lbs



SL7045
VERTICAL KNEE RAISE/DIP STAND

PRODUCT DIMENSION (L×W×H)	1189×765×1537 (mm) 46.8×30.1×60.5 (in)
PRODUCT WEIGHT	74.3 kg/163.8 lbs
MAX. WEIGHT CAPACITY	150 kg/331 lbs



SL7045OPT
CHIN-UP ATTACHMENT

PRODUCT DIMENSION (L×W×H)	1189×1157×2388 (mm) 46.8×45.6×94.0 (in)
PRODUCT WEIGHT	31.5 kg/69 lbs
MAX. WEIGHT CAPACITY	150 kg/331 lbs



SL7051
ASSISTED NORDIC HAM

PRODUCT DIMENSION (L×W×H)	1648×1323×1684 (mm) 64.9×52.1×66.3 (in)
PRODUCT WEIGHT	101 kg/222.7 lbs
MAX. WEIGHT CAPACITY	100 kg/220.5 lbs



SL7055 BELT SQUAT

PRODUCT DIMENSION (L×W×H)	1972×1541×1137 (mm) 77.6×60.7×44.8 (in)
PRODUCT WEIGHT	146 kg/321.9 lbs
MAX. WEIGHT CAPACITY	300 kg/661 lbs



SL7046
ISO-LATERAL SUPER CHEST PRESS

PRODUCT DIMENSION (L×W×H)	2502×2179×1136 (mm) 98.5×85.8×44.7 (in)
PRODUCT WEIGHT	147.5 kg/325.2 lbs
MAX. WEIGHT CAPACITY	150 kg/331 lbs



SL7047 MULTI HYPER EXTENSION

PRODUCT DIMENSION (L×W×H)	1340×947×765 (mm) 52.8×37.3×30.1 (in)
PRODUCT WEIGHT	55.2 kg/122 lbs
MAX. WEIGHT CAPACITY	150 kg/331 lbs



SL7057 PENDULUM SQUAT

PRODUCT DIMENSION (L×W×H)	2252×1314×1675 (mm) 88.7×51.7×65.9 (in)
PRODUCT WEIGHT	250 kg/551.2 lbs
MAX. WEIGHT CAPACITY	200 kg/440.9 lbs



HSP7051
HIGH PRONE ROW BENCH

PRODUCT DIMENSION (L×W×H)	1790×1310×1180 (mm) 70.5×51.6×46.5 (in)
PRODUCT WEIGHT	80kg/176.4lbs



HSP7053 LEG CURL

PRODUCT DIMENSION (L×W×H)	1705×620×742 (mm) 67.1×24.4×29.2 (in)
PRODUCT WEIGHT	40kg/88.2lbs

HSP7052 HIGH ROW

PRODUCT DIMENSION (L×W×H)	1875×1713×2123 (mm) 73.8×67.4×83.6 (in)
PRODUCT WEIGHT	160kg/352.7lbs



IFP Line >>>

- **Professional:** The 14 sets of products include equipment for exercising various muscle groups such as the chest, shoulder, back, legs, and arms. They are designed in strict accordance with parameters such as human mechanics and muscle force lines. This series of equipment is not limited to the training of conventional large muscle groups, but also takes into account the more specialized movement pattern training and more subdivided product design.
- **Functionality:** The 14 sets of products include several multi-functional products, which can meet the needs of multi-function, multi-muscle group and multi-action without affecting the use of a single function. It greatly solves the requirements of the site environment, two machines to one but not compromise on the function.
- **Simplicity:** On the basis of not sacrificing functionality, IFP series reduces the overall occupied area through structural design, so that more equipment can be arranged in the same area, which meets the needs of fitness practitioners for equipment diversity. And the overall structure is simple, reducing useless structures without affecting the maximum weight capacity, frequency of use, and intensity of use.



Dual-position handle design to meet the needs of trainees with different arm spans and different shoulder press distances.

Inclined backrest to significantly reduce pressure on the lower back while in a seated position.

Pivot point height matched to the user's shoulder height, providing a more comfortable user experience and precise muscle stimulation.

Limited-range mechanism for the moving arm to control its range of motion, preventing overextension and ensuring exercise safety.

IFP1101 SEATED SHOULDER PRESS

PRODUCT DIMENSION (L×W×H)	1579×1520×1069 (mm) 62.2×59.8×42.1 (in)
PRODUCT WEIGHT	87 kg/191.8 lbs
MAX. WEIGHT CAPACITY	300 kg/661.4 lbs



The height of the turning point matches the height of the user's shoulder, giving the user a more comfortable experience and precise stimulation of muscle groups.

Limit the use range of the lift-arm to avoid overextension.

The movable handle can meet the holding positions of users with different arm spans.

IFP1103 STANDING LATERAL RAISE

PRODUCT DIMENSION (L×W×H)	1165×885×1550 (mm) 45.9×34.8×61.0 (in)
PRODUCT WEIGHT	57.3 kg/126.3 lbs
MAX. WEIGHT CAPACITY	200 kg/440.9 lbs



IFP1201 SEATED CHEST PRESS

PRODUCT DIMENSION (L×W×H)	1276×984×1248 (mm) 50.2×38.7×49.1 (in)
PRODUCT WEIGHT	64.2 kg/141.5lbs
MAX. WEIGHT CAPACITY	200 kg/440.9 lbs



IFP1206 STANDING CHEST FLY

PRODUCT DIMENSION (L×W×H)	1515×1310×1491 (mm) 59.6×51.6×58.7 (in)
PRODUCT WEIGHT	70 kg/154.3 lbs
MAX. WEIGHT CAPACITY	200 kg/440.9 lbs



IFP1301 LAT PULLDOWN

PRODUCT DIMENSION (L×W×H)	1703×1339×2047 (mm) 67.0×52.7×80.6 (in)
PRODUCT WEIGHT	95 kg/216.1 lbs
MAX. WEIGHT CAPACITY	200 kg/440.9 lbs



IFP1302 SEATED ROW

PRODUCT DIMENSION (L×W×H)	1470×1020×1340 (mm) 57.9×40.2×52.8 (in)
PRODUCT WEIGHT	77.5 kg/170.9 lbs
MAX. WEIGHT CAPACITY	200 kg/440.9 lbs

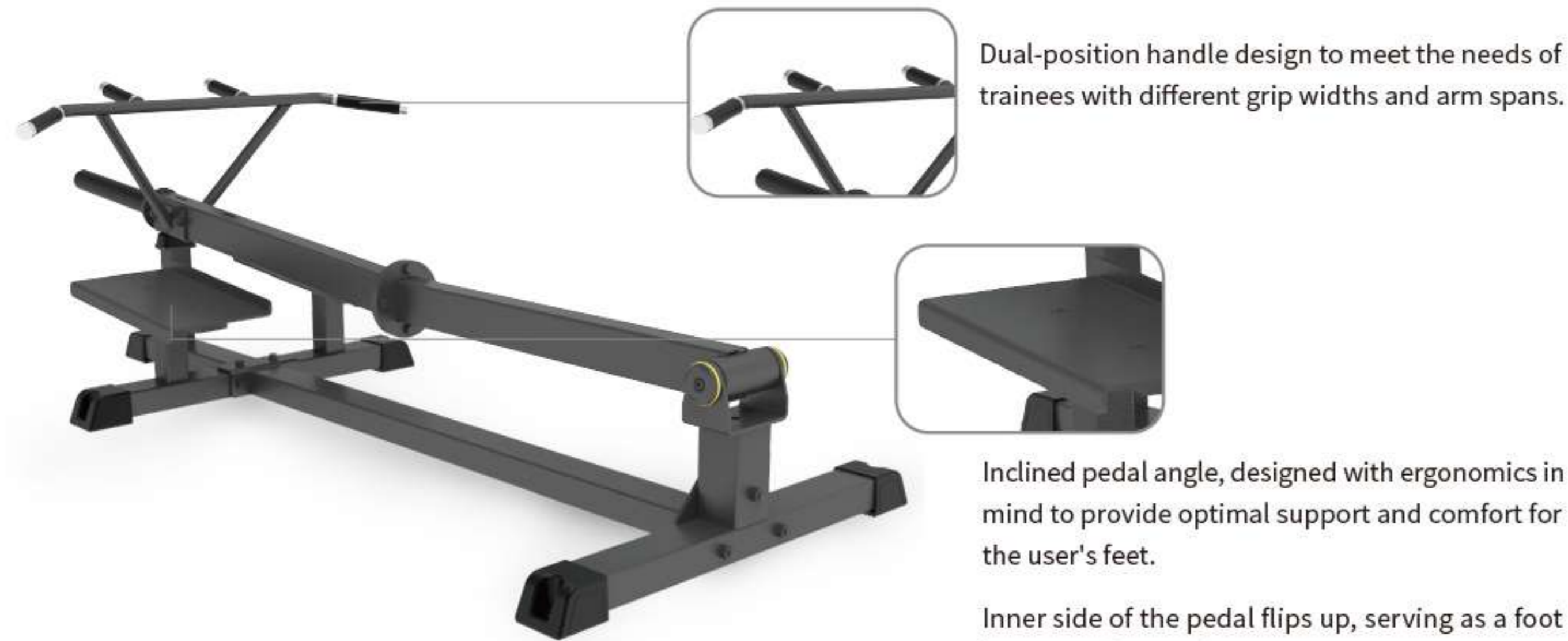

Dual-position handle design to meet the needs of trainees with different grip widths and arm spans.

Inclined pedal angle, designed with ergonomics in mind to provide optimal support and comfort for the user's feet.

Inner side of the pedal flips up, serving as a foot limitation feature for the user.

IFP1305 T-BAR ROW

PRODUCT DIMENSION (L×W×H)	2079×908×635 (mm) 81.9×35.7×25.0 (in)
PRODUCT WEIGHT	23 kg/50.7 lbs
MAX. WEIGHT CAPACITY	150 kg/330.7 lbs

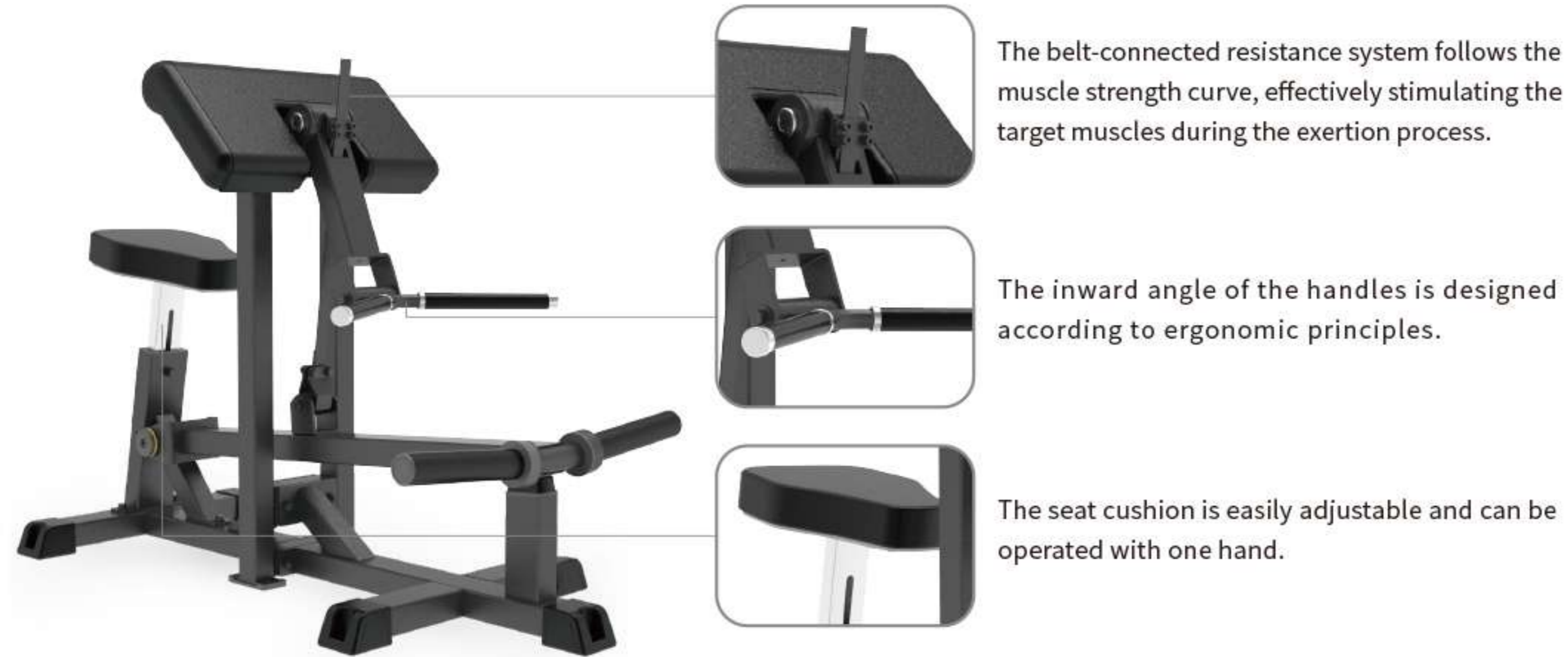

The belt-connected resistance system follows the muscle strength curve, effectively stimulating the target muscles during the exertion process.

The inward angle of the handles is designed according to ergonomic principles.

The seat cushion is easily adjustable and can be operated with one hand.

IFP1501 BICEP CURL

PRODUCT DIMENSION (L×W×H)	1302×707×988 (mm) 51.3×27.8×38.9 (in)
PRODUCT WEIGHT	56 kg/123.5 lbs
MAX. WEIGHT CAPACITY	200 kg/440.9 lbs



The leg pads are 360° adjustable and can be adjusted according to the ankles of users of different heights to meet various needs.

The connecting rod structure solves the phenomenon of losing power in the back of the trajectory, and better stimulates the target muscles in the whole process.

IFP1604 PRONE LEG CURL

PRODUCT DIMENSION (L×W×H)	1623×1202×798 (mm) 63.9×47.3×31.4 (in)
PRODUCT WEIGHT	75.9 kg/167.3 lbs
MAX. WEIGHT CAPACITY	150 kg/330.7 lbs



The automatic locking latch type back pad adjustment can be adjusted according to users of different heights, and can be operated with one hand, which is convenient to use.

The leg pads are 360° adjustable and can be adjusted according to the ankles of users of different heights to meet various needs.

IFP1605 SEATED LEG EXTENSION

PRODUCT DIMENSION (L×W×H)	1246×1173×995 (mm) 49.1×46.2×39.2 (in)
PRODUCT WEIGHT	63.4 kg/139.8 lbs
MAX. WEIGHT CAPACITY	150 kg/330.7 lbs



Equipped with starting handle, the position is convenient for users to operate, safe and reliable.

Multi-level safety limit provides multiple starting positions to meet the needs of users of different heights.

There are handles at the bottom and next to the foot pedal, which are convenient for users to get on and off the machine.

The back pad is angled to fit the angle of the body during the kick to avoid excessive backward pelvis.

IFP1613 VERTICAL LEG PRESS

PRODUCT DIMENSION (L×W×H)	1655×1214×1711 (mm) 65.2×47.8×67.4 (in)
PRODUCT WEIGHT	110.4 kg/243.4 lbs
MAX. WEIGHT CAPACITY	350 kg/771.6 lbs



Fixed armrests, users can hold on to stabilize the core muscles during training, and focus more on lower limbs.

The starting handle with the spring can automatically spring back after starting, providing convenience for users.

Multiple belt hanging points to meet the needs of users of different heights.

Equipped with fast buckle belt, easy for users to get on and off the machine.

IFP1615 BELT SQUAT

PRODUCT DIMENSION (L×W×H)	1615×1250×1032 (mm) 63.6×49.2×40.6 (in)
PRODUCT WEIGHT	77.5kg/170.9 lbs
MAX. WEIGHT CAPACITY	350 kg/771.6 lbs



The height of the leg pad can be adjusted for easy user access to the machine.

The leg pad can be adjusted both forward and backward, accommodating users of different heights and leg lengths.

The pedal angle is inclined and coated with non-slip paint.

Elastic band attachment points allow for maximum stimulation of the target muscle groups without loss of tension at the end of the range of motion.

IFP1616 VERTICAL HIP THRUST

PRODUCT DIMENSION (L×W×H)	1220×1098×1165 (mm) 48.0×43.2×45.9 (in)
PRODUCT WEIGHT	67.5 kg/148.8 lbs
MAX. WEIGHT CAPACITY	150 kg/330.7 lbs



The back pad is divided into two pieces and is interlocked at an angle to better fit the user's back, which is ergonomic and provides enough support for the user's back. Meanwhile, the split back pad design is convenient for later maintenance and replacement.

The safety limit has two adjustable levels to meet the needs of users of different heights.

IFP1617 HACK SQUAT

PRODUCT DIMENSION (L×W×H)	1982×1485×1318 (mm) 78.0×58.5×51.9 (in)
PRODUCT WEIGHT	100.6 kg/221.8 lbs
MAX. WEIGHT CAPACITY	350 kg/771.6 lbs

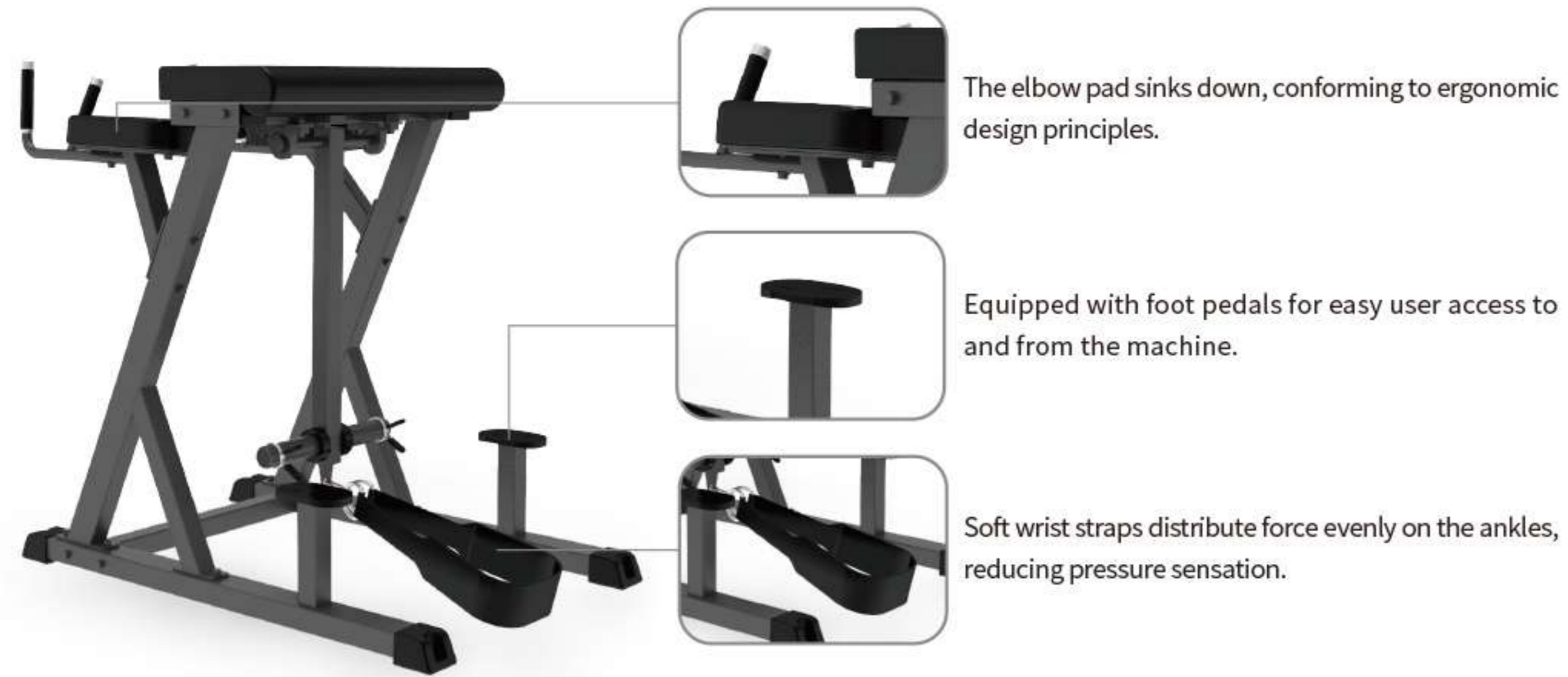

IFP1619 REVERSE HYPEREXTENSION

PRODUCT DIMENSION (L×W×H)	1310×797×1153 (mm) 51.6×31.4×45.4 (in)
PRODUCT WEIGHT	66 kg/145.5 lbs
MAX. WEIGHT CAPACITY	100 kg/220.5 lbs



IFP1622 STANDING HIP ABDUCTOR

PRODUCT DIMENSION (L×W×H)	1720×595×1280 (mm) 67.7×23.4×50.4 (in)
PRODUCT WEIGHT	83.9kg/185.0 lbs
MAX. WEIGHT CAPACITY	150 kg/330.7 lbs



IFP1623 SEATED CALF RAISE

PRODUCT DIMENSION (L×W×H)	1368×566×849 (mm) 53.9×22.3×33.4 (in)
PRODUCT WEIGHT	38.5kg/84.9 lbs
MAX. WEIGHT CAPACITY	100 kg/220.5 lbs



IFP1706 BICEPS/TRICEPS

PRODUCT DIMENSION (L×W×H)	1092×708×1287 (mm) 43.0×27.9×50.7 (in)
PRODUCT WEIGHT	47.3 kg/104.3 lbs
MAX. WEIGHT CAPACITY	200 kg/440.9 lbs



IFP1707 LEVERAGE SQUAT/CALF

PRODUCT DIMENSION (L×W×H)	1490×1445×1550 (mm) 58.7×56.9×61.0 (in)
PRODUCT WEIGHT	115.5 kg/254.6 lbs
MAX. WEIGHT CAPACITY	350 kg/771.6 lbs

The shoulder pads are rounded and ergonomically designed to make the user's shoulders fit better.

Double-angled shoulder pads prevent the user's shoulders from sliding on the shoulder pads.

The starting handle cooperates with the spring to automatically rebound. After the user starts, the middle support structure automatically rebounds and is still within the controllable range of the user's hand.

The starting height can be adjusted to meet the needs of users of different heights.

The pedals are bent for calf training.



IFP1711 HACK SQUAT/LEG PRESS

PRODUCT DIMENSION (L×W×H)	2634×1020×1373 (mm) 103.7×40.2×54.1 (in)
PRODUCT WEIGHT	150.5 kg/331.8 lbs
MAX. WEIGHT CAPACITY	350 kg/771.6 lbs

Both the foot pedal and shoulder pads can be folded and retracted with one hand to provide convenience for the user to switch between the Huck squat and reverse leg press functions.

The safety handles are easily accessible on both sides, which ensure the safety during use.

The foot pedal angle adjustment can be operated with one hand, which is convenient for users to adjust.



IFP1721 HALF CAGE/SMITH MACHINE

PRODUCT DIMENSION (L×W×H)	1404×1850×2343 (mm) 55.3×72.8×92.2 (in)
PRODUCT WEIGHT	77.5 kg/170.9 lbs
MAX. WEIGHT CAPACITY	250 kg/551.2 lbs

Multi-functional equipment, equipped with multiple-position pull-up handles to meet the user's needs for different exercises.

Smith machine with multiple attachment points, allowing users to start and stop the training at any height.

Equipped with smith machine safety stops to protect users from injuries due to bar disengagement.

Rail travel range accommodates floor exercises such as bent-over rows, deadlifts, and hip thrusts.

Front-side equipped with squat safety hooks and safety stops, meeting the user's training needs for free-weight squats.



Dual-function attachments for high pulldown and seated row exercises, meeting the user's need for versatile training options.

Equipped with handle hooks as standard.

IFP1721OPT LAT PULLDOWN SEATED ROW ATTACHMENT

PRODUCT DIMENSION (L×W×H)	1451×1231×2307 (mm) 57.1×48.5×90.8 (in)
PRODUCT WEIGHT	38.6 kg/85.1 lbs
MAX. WEIGHT CAPACITY	200 kg/440.9 lbs

IT7 Line >>>





IT7001 SMITH

PRODUCT DIMENSION (L×W×H)	2241×1326×2370 (mm) 88.2×52.2×93.3 (in)
PRODUCT WEIGHT	178 kg / 392 lbs
40'	58 Sets
MAX. WEIGHT CAPACITY	200 kg / 440 lbs



IT7002 SEATED PREACHER CURL

PRODUCT DIMENSION (L×W×H)	919×803×882 (mm) 36.2×31.6×34.7 (in)
PRODUCT WEIGHT	41 kg / 90 lbs
40'	260 Sets



IT7004 STRETCH

PRODUCT DIMENSION (L×W×H)	1274×552×997 (mm) 50.2×21.7×39.3 (in)
PRODUCT WEIGHT	35 kg / 77 lbs
40'	280 Sets



IT7005 SEATED CALF RAISE

PRODUCT DIMENSION (L×W×H)	1356×751×831 (mm) 53.4×29.6×32.7 (in)
PRODUCT WEIGHT	50 kg / 110 lbs
40'	297 Sets
MAX. WEIGHT CAPACITY	100 kg / 220 lbs



* COLOR OPTIONAL.



IT7003 AB BENCH

PRODUCT DIMENSION (L×W×H)	1745×936×997 (mm) 68.7×36.9×39.3 (in)
PRODUCT WEIGHT	57 kg / 126 lbs
40'	110 Sets



IT7006 LEG PRESS/HACK SQUAT

PRODUCT DIMENSION (L×W×H)	2253×975×1475 (mm) 88.7×38.4×58.1 (in)
PRODUCT WEIGHT	166.3 kg / 367 lbs
40'	66 Sets
MAX. WEIGHT CAPACITY	200 kg / 440 lbs



IT7007 MULTI HYPEREXTENSION

PRODUCT DIMENSION (L×W×H)	1312×749×814 (mm) 51.7×29.5×32 (in)
PRODUCT WEIGHT	43.5 kg / 96 lbs
40'	231 Sets



IT7019 INCLINE ROW

PRODUCT DIMENSION (L×W×H)	1965×1009×1262 (mm) 77.4×39.7×49.7 (in)
PRODUCT WEIGHT	77.5 kg / 171 lbs
40'	140 Sets
MAX. WEIGHT CAPACITY	150 kg / 330 lbs



IT7020 45 LEG PRESS

PRODUCT DIMENSION (L×W×H)	2199×1016×1494 (mm) 86.6×40×58.8 (in)
PRODUCT WEIGHT	140.5 kg / 310 lbs
40'	71 Sets
MAX. WEIGHT CAPACITY	200 kg / 440 lbs



IT7014 FLAT BENCH PRESS

PRODUCT DIMENSION (L×W×H)	1657×1658×1373 (mm) 65.2×65.3×54.1 (in)
PRODUCT WEIGHT	82 kg / 181 lbs
40'	126 Sets



IT7014OPT SPOTTER STAND

PRODUCT DIMENSION (L×W×H)	661×442×262 (mm) 26.0×17.4×10.3 (in)
PRODUCT WEIGHT	25.1 kg/55.2 lbs
40'	680 Sets



IT7010 VERTICAL KNEE RAISE

PRODUCT DIMENSION (L×W×H)	1131×781×1515 (mm) 44.5×30.7×59.6 (in)
PRODUCT WEIGHT	53 kg / 117 lbs
40'	160 Sets



IT7010EOPT CHIN-UP ATTACHMENT

DIMENSION (L×W×H)	2299×930×660 (mm) 90.5×36.6×26 (in)
PRODUCT WEIGHT	30.5kg/67.3lbs



IT7015 INCLINE BENCH PRESS

PRODUCT DIMENSION (L×W×H)	1632×1658×1373 (mm) 64.3×65.3×54.1 (in)
PRODUCT WEIGHT	106.5 kg / 235 lbs
40'	112 Sets



IT7016 DECLINE BENCH PRESS

PRODUCT DIMENSION (L×W×H)	2103×1658×1370 (mm) 82.8×65.3×53.9 (in)
PRODUCT WEIGHT	87 kg / 192 lbs
40'	126 Sets



IT7013 MULTI AB BENCH

PRODUCT DIMENSION (L×W×H)	1738×725×899 (mm) 68.4×28.5×35.4 (in)
PRODUCT WEIGHT	42.5 kg / 94 lbs
40'	140 Sets



IT7009 FLAT BENCH

PRODUCT DIMENSION (L×W×H)	1200×748.6×426(mm) 47.2×29.5×16.8 (in)
PRODUCT WEIGHT	27.5 kg / 61 lbs
40'	220 Sets



IT7011 MULTI-ADJUSTABLE BENCH

PRODUCT DIMENSION (L×W×H)	1212×750×465 (mm) 47.7×29.5×18.3 (in)
PRODUCT WEIGHT	40 kg / 88 lbs
40'	207 Sets



IT7022 UTILITY BENCH

PRODUCT DIMENSION (L×W×H)	1165×603×818 (mm) 45.9×23.7×32.2 (in)
PRODUCT WEIGHT	21.3 kg / 47 lbs
40'	308 Sets



IT7030 ROMAN CHAIR

DIMENSION (L×W×H)	985×726×625 (mm) 38.8×28.6×24.6 (in)
PRODUCT WEIGHT	35kg/77.2lbs

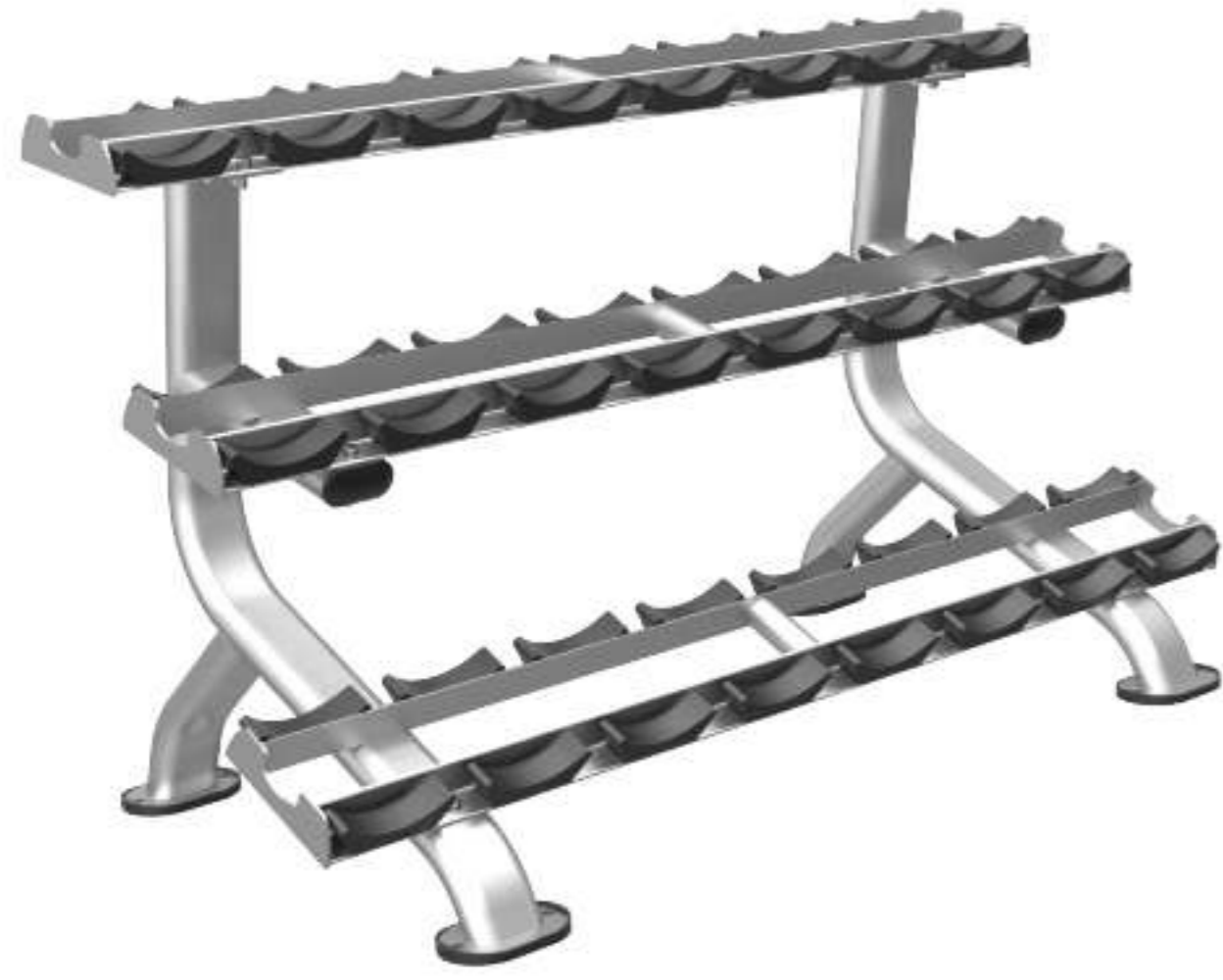

IT7012 DUMBBELL RACK

PRODUCT DIMENSION (L×W×H)	1508×814×938(mm) 59.4×32.0×36.9(in)
PRODUCT WEIGHT	71kg/156lbs
40'	140Sets



IT7018 DUMBBELL RACK

PRODUCT DIMENSION (L×W×H)	1580×814×982 (mm) 62.2×32×38.7 (in)
40'	140 Sets



IT7031 SHOULDER BENCH PRESS

DIMENSION (L×W×H)	1349×1126×1651(mm) 53.1×44.3×65(in)
PRODUCT WEIGHT	86.5 kg/190.9 lbs
MAX. WEIGHT CAPACITY	300 kg/660 lbs



IT7017 WEIGHT PLATE TREE

PRODUCT DIMENSION (L×W×H)	950×610×1220 (mm) 37.4×24×48 (in)
PRODUCT WEIGHT	26 kg / 57 lbs
40'	264 Sets



IT7027 BARBELL RACK

PRODUCT DIMENSION (L×W×H)	919×907×1612 (mm) 36.2×35.7×63.5 (in)
PRODUCT WEIGHT	68 kg / 150 lbs
40'	112 Sets



IT7032 OLYMPIC BAR RACK

DIMENSION (L×W×H)	960×710×1086(mm) 37.8×28×42.8(in)
PRODUCT WEIGHT	47 kg/103.7 lbs
MAX. WEIGHT CAPACITY	300 kg/660 lbs

IT7033 MAX RACK

DIMENSION (L×W×H)	2000×1410×2185(mm) 78.7×55.5×86(in)
PRODUCT WEIGHT	199.4 kg/440 lbs
MAX. WEIGHT CAPACITY	200 kg/440 lbs



IF Line >>>





IFHC HALF CAGE

PRODUCT DIMENSION (L×W×H)	1681×1720×2090 (mm) 66.2×67.7×82.3 (in)
PRODUCT WEIGHT	100 kg / 221 lbs
40'	150 Sets



IFHCL HALF CAGE LAT ATTACHMENT

PRODUCT DIMENSION (L×W×H)	1800×400×2100 (mm) 70.9×15.7×82.7 (in)
PRODUCT WEIGHT	41 kg / 90 lbs
40'	234 Sets



IFHCS HALF CAGE SMITH ATTACHMENT

PRODUCT DIMENSION (L×W×H)	1946×300×1727 (mm) 76.6×11.8×68 (in)
PRODUCT WEIGHT	33 kg / 73 lbs
40'	425 Sets
MAX. WEIGHT CAPACITY	200 kg / 440 lbs

IFLATM LAT MACHINE

PRODUCT DIMENSION (L×W×H)	1452×1224×2129 (mm) 57.2×48.2×83.8 (in)
PRODUCT WEIGHT	55.5 kg / 122 lbs
40'	302 Sets



IFPC POWER CAGE

PRODUCT DIMENSION (L×W×H)	1576×1256×2149 (mm) 62.0×49.4×84.6 (in)
PRODUCT WEIGHT	114 kg / 251 lbs
40'	90 Sets

IFPCL POWER CAGE LAT ATTACHMENT

PRODUCT DIMENSION (L×W×H)	1212×945×2053 (mm) 47.7×37.2×80.8 (in)
PRODUCT WEIGHT	31.8 kg / 70 lbs
40'	420 Sets





IF45 45-DEGREE HYPEREXTENSION

PRODUCT DIMENSION (L×W×H)	1224×743×739 (mm) 48.2×29.3×29.1 (in)
PRODUCT WEIGHT	23.5 kg / 52 lbs
40'	340 Sets



IFAH ADJUSTABLE HYPEREXTENSION BENCH

PRODUCT DIMENSION (L×W×H)	1260×743×917 (mm) 49.6×29.3×36.1 (in)
PRODUCT WEIGHT	36 kg / 79 lbs
40'	360 Sets



IFRC ROMAN CHAIR

PRODUCT DIMENSION (L×W×H)	1361×743×1091 (mm) 53.6×29.3×43 (in)
PRODUCT WEIGHT	30.5 kg / 67 lbs
40'	504 Sets



IFFB FLAT BENCH

PRODUCT DIMENSION (L×W×H)	1303×526×490 (mm) 51.3×20.7×19.3 (in)
PRODUCT WEIGHT	19.5 kg / 43 lbs
40'	532 Sets



IFUB UTILITY BENCH

PRODUCT DIMENSION (L×W×H)	862×596×874 (mm) 33.9×23.5×34.4 (in)
PRODUCT WEIGHT	12.7 kg / 28 lbs
40'	375 Sets



IFFI FLAT/INCLINE BENCH

PRODUCT DIMENSION (L×W×H)	1603×654×498 (mm) 63.1×25.7×19.6 (in)
PRODUCT WEIGHT	30 kg / 66 lbs
40'	396 Sets



IFSPC SEATED PREACHER CURL

PRODUCT DIMENSION (L×W×H)	1021×712×870 (mm) 40.2×28×34.3 (in)
PRODUCT WEIGHT	24.7 kg / 54 lbs
40'	420 Sets



IFAAB ADJUSTABLE ABDOMINAL BENCH

PRODUCT DIMENSION (L×W×H)	1624×570×1115 (mm) 63.9×22.4×43.9 (in)
PRODUCT WEIGHT	24 kg / 53 lbs
40'	450 Sets



IFAC ABDOMINAL CRUNCH

PRODUCT DIMENSION (L×W×H)	1103×476×578 (mm) 43.4×18.7×22.8 (in)
PRODUCT WEIGHT	17 kg / 37 lbs
40'	697 Sets



IFOB OLYMPIC BENCH PRESS

PRODUCT DIMENSION (L×W×H)	1439×1264×1086 (mm) 56.7×49.8×42.8 (in)
PRODUCT WEIGHT	62.5 kg / 138 lbs
40'	252 Sets



IFARMA ARM CURL ATTACHMENT

PRODUCT DIMENSION (L×W×H)	584×434×761 (mm) 23×17.1×30 (in)
PRODUCT WEIGHT	6.6 kg / 15 lbs
40'	840 Sets



IFLEGA LEG EXTENSION/CURL ATTACHMENT

PRODUCT DIMENSION (L×W×H)	539×426×470 (mm) 21.2×16.8×18.5 (in)
PRODUCT WEIGHT	7.3 kg / 16 lbs
40'	1728 Sets



**IFSTF
STRETCH**

PRODUCT DIMENSION (L×W×H)	1865×1730×2150 (mm) 73.4×68.1×84.6 (in)
PRODUCT WEIGHT	90 kg / 198 lbs
40'	112 Sets



**IFPT
POWER TOWER**

PRODUCT DIMENSION (L×W×H)	1242×1316×2113 (mm) 48.9×51.8×83.2 (in)
PRODUCT WEIGHT	76.5 kg / 169 lbs
40'	245 Sets



**IFSS
SQUAT STAND**

PRODUCT DIMENSION (L×W×H)	1226×1575×1735 (mm) 48.3×62×68.3 (in)
PRODUCT WEIGHT	56.5 kg / 125 lbs
40'	320 Sets



**IFOFB
FLAT BENCH PRESS**

PRODUCT DIMENSION (L×W×H)	1525×1310×1265 (mm) 60×51.6×49.8 (in)
PRODUCT WEIGHT	60.5 kg / 133 lbs
40'	154 Sets



**IFOIB
INCLINE BENCH PRESS**

PRODUCT DIMENSION (L×W×H)	1560×1310×1395 (mm) 61.4×51.6×54.9 (in)
PRODUCT WEIGHT	68.5 kg / 151 lbs
40'	147 Sets



**IFLPHS
LEG PRESS/HACK SQUAT MACHINE**

PRODUCT DIMENSION (L×W×H)	2245×818×1298 (mm) 88.4×32.2×51.1 (in)
PRODUCT WEIGHT	162.5 kg / 358 lbs
40'	108 Sets
MAX. WEIGHT CAPACITY	200 kg / 440 lbs



**IFFID
MULTI-PURPOSE BENCH**

PRODUCT DIMENSION (L×W×H)	1582×655×501 (mm) 62.3×25.8×19.7 (in)
PRODUCT WEIGHT	33 kg / 73 lbs
40'	417 Sets



**IFODB
DECLINE BENCH PRESS**

PRODUCT DIMENSION (L×W×H)	1900×1310×1156 (mm) 74.8×51.6×45.5 (in)
PRODUCT WEIGHT	70 kg / 154 lbs
40'	154 Sets





**IFLEGM
LEG EXTENSION/CURL MACHINE**

PRODUCT DIMENSION (L×W×H)	1055×1044×1053 (mm) 41.5×41.1×41.5 (in)
PRODUCT WEIGHT	51 kg / 112 lbs
40'	192 Sets



**IFCR
CALF RAISE**

PRODUCT DIMENSION (L×W×H)	1207×559×1016 (mm) 43.3×22.0×40.0 (in)
PRODUCT WEIGHT	47.5 kg / 78 lbs
40'	520 Sets
MAX. WEIGHT CAPACITY	100 kg / 220 lbs



**IFBR
BARBELL RACK**

PRODUCT DIMENSION (L×W×H)	792×844×1380 (mm) 31.2×33.2×54.3 (in)
PRODUCT WEIGHT	43.7 kg / 96 lbs
40'	195 Sets



**IFPTO
PLATE TREE-OLYMPIC**

PRODUCT DIMENSION (L×W×H)	843×632×1108 (mm) 33.2×24.9×43.6 (in)
PRODUCT WEIGHT	19.5 kg / 43 lbs
40'	890 Sets



**IFDB3
DUMBBELL RACK-3'**

PRODUCT DIMENSION (L×W×H)	1079×473×677 (mm) 42.5×18.6×26.7 (in)
PRODUCT WEIGHT	29 kg / 64 lbs
40'	600 Sets



**IFDB4
DUMBBELL RACK-4'**

PRODUCT DIMENSION (L×W×H)	1372×475×869 (mm) 54×18.7×34.2 (in)
PRODUCT WEIGHT	35.3 kg / 78 lbs
40'	430 Sets



**IFDB4A
DUMBBELL RACK-4' ATTACHMENT**

PRODUCT DIMENSION (L×W×H)	1242×244×74 (mm) 48.9×9.6×2.9 (in)
PRODUCT WEIGHT	12 kg / 26 lbs
40'	1400 Sets



HG5 CABLE MOTION GYM

PRODUCT DIMENSION (L×W×H)	1451×1339×2132 (mm) 57.1×52.7×83.9 (in)
PRODUCT WEIGHT	195.9 kg / 431.9 lbs
40'	82 Sets
WEIGHT STACK	73 kg / 160 lbs



IFFI5 BENCH

PRODUCT DIMENSION (L×W×H)	1380x490x441(mm) 54.3x19.3x17.3(in)
PRODUCT WEIGHT	25.7kgs/56.7lbs
MAX WEIGHT CAPACITY	200kg/441lbs



MULTI GYMS & DAP >>>



ES3000 3 STACK MULTI-STATION

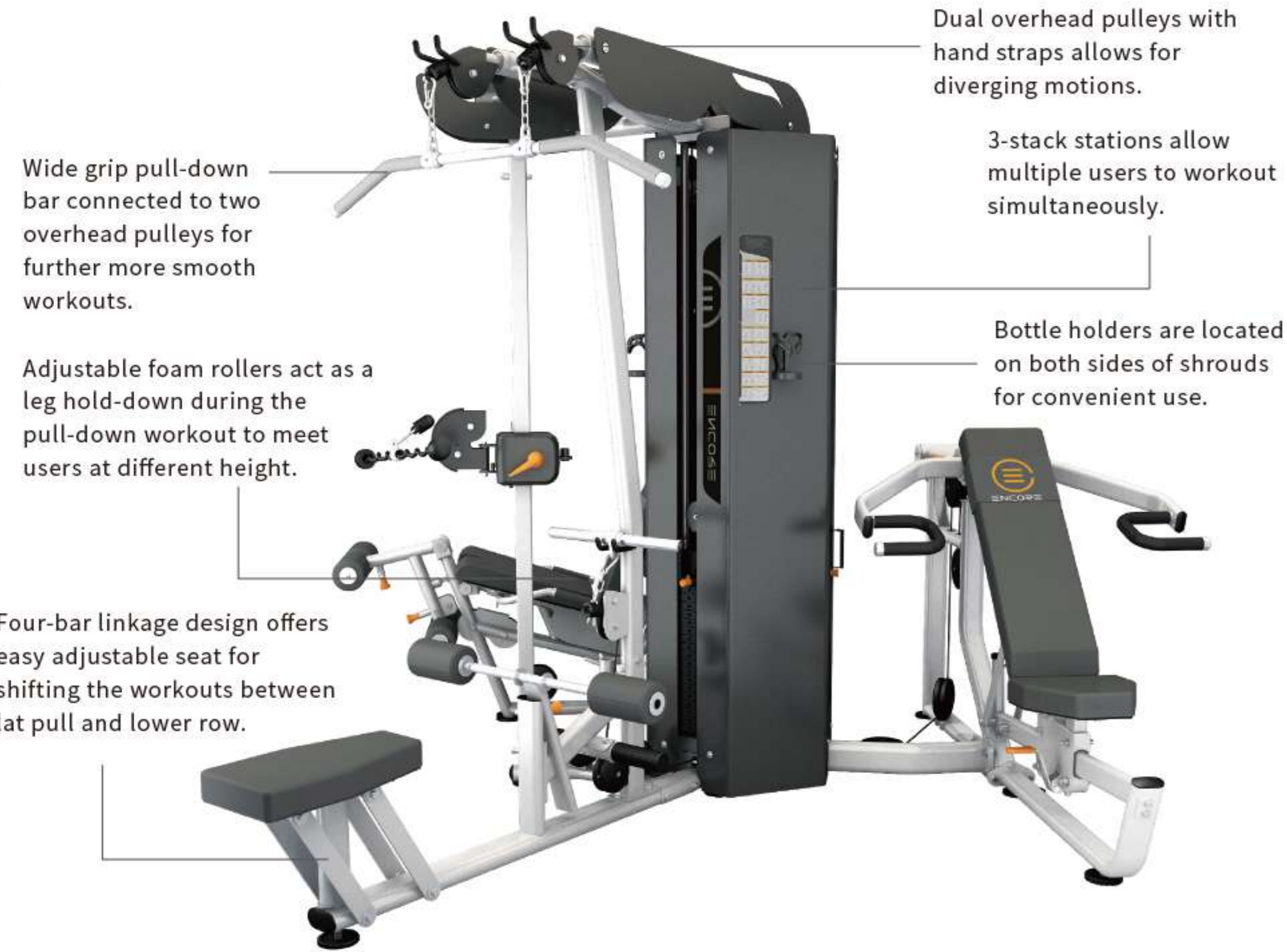

Product Dimension (L×W×H)	2694x2440x2148(mm) 106.1x96.1x84.6(in)
Product Weight	299.9kg/661.2lbs
Stacks Weight	91kgx3 (200lbsx3)
OPT Weight	26.5kg

ES3000 OPT HI-LO PULLEY ATTACHMENT

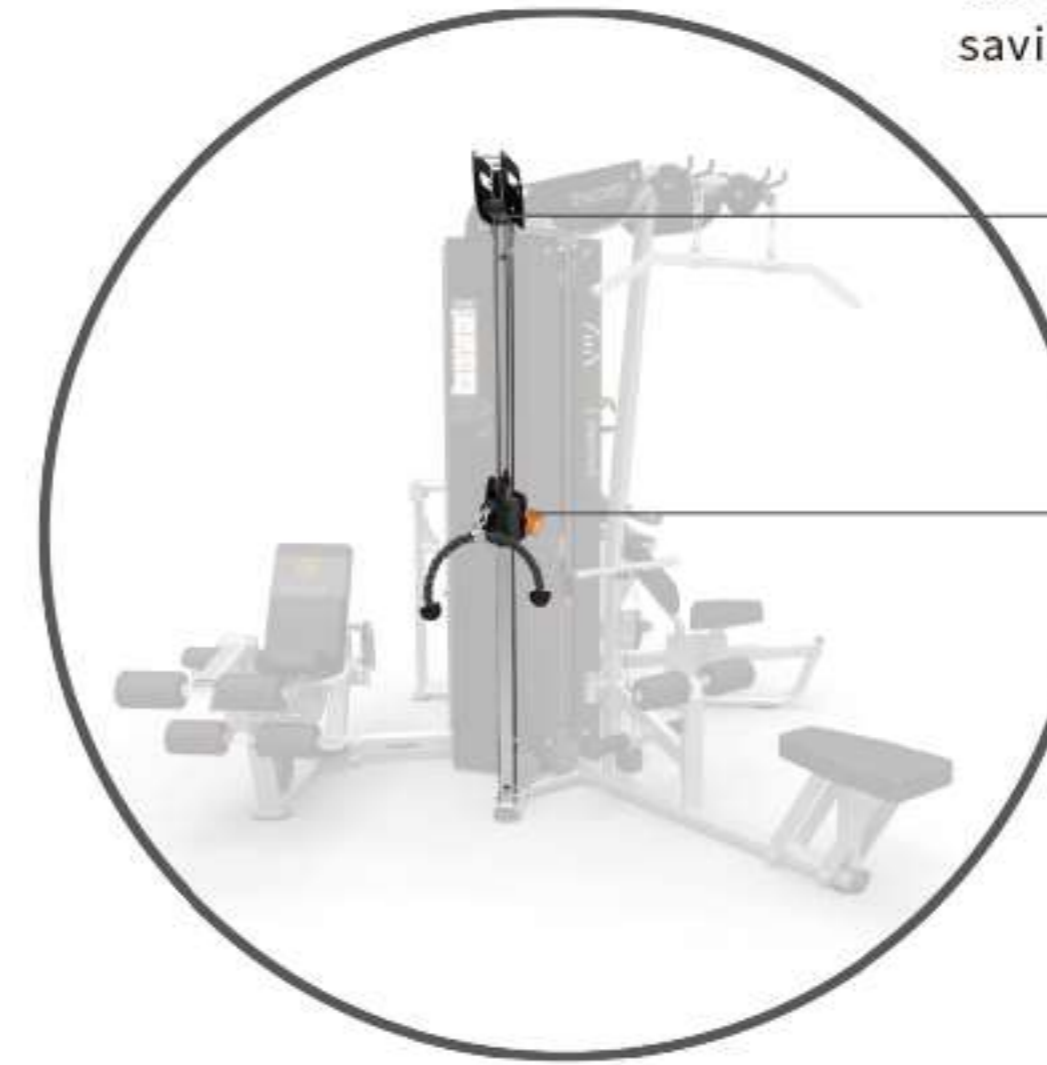

Quick installation, shares the stack with lat pull for saving space and cost.



31 vertical pulley positions for a large variety of different exercises.



Adjustable handle is conveniently located for easy access.

Excellent structural design, easy & quick adjustment seat is for prone leg curls or leg extension exercises which satisfy various muscle groups.

ES9030 DUAL ADJUSTABLE PULLEY ES7011 BENCH



Chin-up/pull-up bar with ergonomic bends for regular grip, wide grip and reverse grip exercises.

31 vertical pulley positions for a large variety of different exercises.

With accessories as lat strap, long bar retractable strap, leg ext/curl strap and tricep rope, DAP offers users dynamic and various workouts.

Multi-position bench offers 5 upright/incline positions for back pad and 3 position for seat, which satisfies various workout experience.

The over-sized feet would stabilize the users during certain workouts like tricep extension.

Conveniently located iPad holder allows user to watch online training videos during the workouts, over-sized bottle holder is within reach.



Fold away bench for easy storage and space saving



ES9030(Long Shroud)

Product Dimension (L×W×H)	1734x1123x2150(mm) 68.3x44.2x84.7(in)
Product Weight	149.5kg/328.9lbs
Stacks Weight	77kgx2 (170lbsx2)



ES9030(Short Shroud)

Product Dimension (L×W×H)	1734x1123x2150(mm) 68.3x44.2x84.7(in)
Product Weight	121.5kg/267.3lbs
Stacks Weight	77kgx2 (170lbsx2)



ES7011

Product Dimension (L×W×H)	1440x525x490(mm) 56.7x20.7x19.3(in)
Product Weight	34.3kg/75.6lbs

Chest

- Incline Press
- Chest Press
- Decline Press
- Pec Fly
- Incline Press
- Chest Press

Arms

- Bicep Curl
- Tricep Press Down

Core

- Core Rotation
- Core Rotation Incline
- Core Rotation Decline

Back

- High Row
- Mid Row
- Low Row
- Rear Deltoid
- Pull Up

Lower Body

- Squat
- Lunge
- Lunge-Decelerating
- Hip Adduction
- Hip Abduction
- Hip Flexion
- Hip Extension
- Kick Back
- Leg Extension
- Leg Curl

Shoulders

- Seated Shoulder Press
- Lateral Raise
- Internal Rotation
- External Rotation
- Upright Row
- Shoulder Press

ES7030 DUAL ADJUSTABLE PULLEY



Chin-up/pull-up bar with ergonomic bends for regular grip, wide grip and reverse grip exercises.

31 vertical pulley positions for a large variety of different exercises.

With accessories as lat strap, long bar retractable strap, leg ext/curl strap and tricep rope, DAP offers users dynamic and various workouts.
*Accessories sold separately.



TENSION ROPE

Product Dimension	650(mm)/25.6 (in)
Pull	≥450kg/992.1lbs



HANDLE

Product Dimension	1126x35(mm) 44.3x1.4(in)
-------------------	-----------------------------



ES7030

Product Dimension (L×W×H)	1641x916x2142(mm) 64.6x36.1x84.3(in)
Stacks Weight	77kgx2 (170lbsx2)

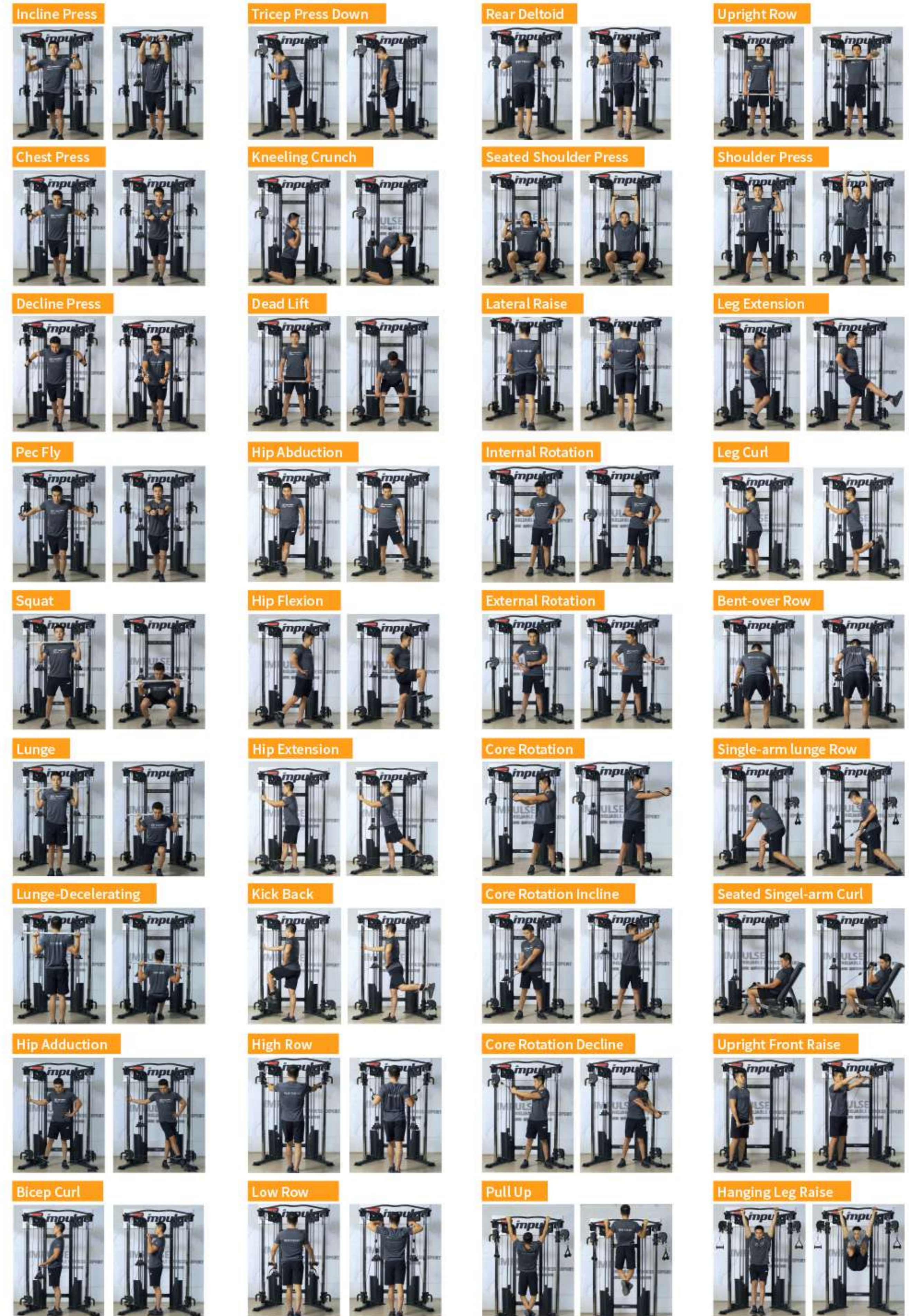

ES2100 Multi-Functional Trainer with Smith

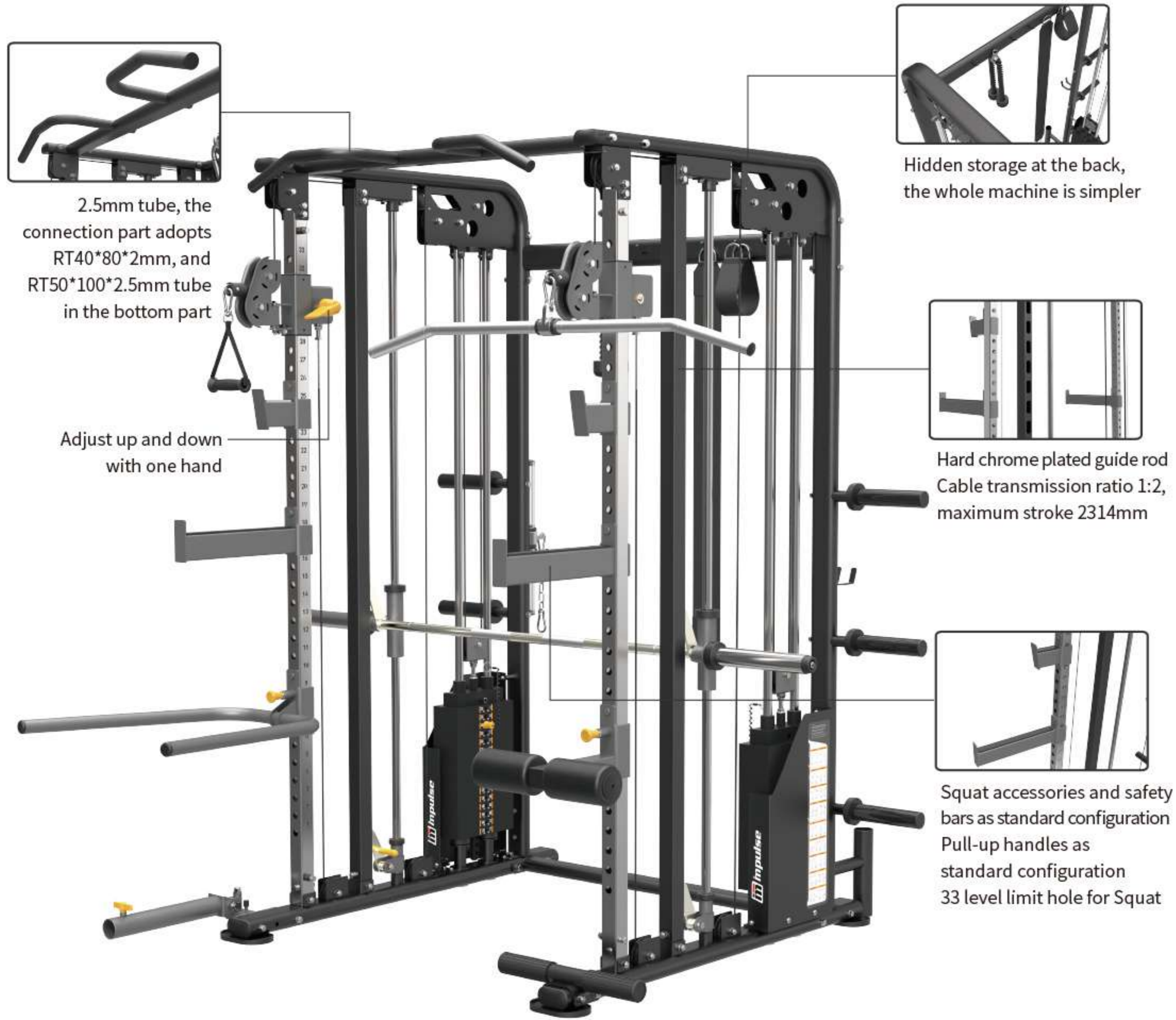

Product Dimension (L×W×H)	1681x1720x2090(mm) 66.18x67.72x82.28(in)
Product Weight	186.1kg/410.3lbs
Opt Weight Stack	170lbs/200lbs x 2 sets

ES2000 Multi-Functional Trainer with Smith (Plate Loaded)



Product Dimension (L×W×H)	2007x1724x2126(mm) 79.01x67.87x83.70(in)
Product Weight	184kg/405.7lbs

ES2000/2100 Accessory

Standard	POM Handle	Short Pole	Support Strap	Dip Arm
	Barbell Bar Storage	Ankle Strap	Double-ended Rope	Rowing Foot Pedal
Optional	ES2000OPT1 Pivot	ES2000OPT2 Foam Roller + Hi Pull-down Aluminum Rod		PTSHILO15000 Chop Bar

IF2060
2060 HOME GYM

PRODUCT DIMENSION (L×W×H)	3585×2640×2120 (mm) 141.1×103.9×83.5 (in)
PRODUCT WEIGHT	442.8 kg / 976 lbs
40'	40 Sets
WEIGHT STACK	2×91 kg / 200 lbs



IFLP3
HOME GYM ATTACHMENT

PRODUCT DIMENSION (L×W×H)	1990×1040×895 (mm) 78.3×40.9×35.2 (in)
PRODUCT WEIGHT	65 kg / 143 lbs
40'	220 Sets



IF1560+IFLP3



IF2060+IFLP3



IF1560
1560 HOME GYM

PRODUCT DIMENSION (L×W×H)	2195×1235×2120 (mm) 86.4×48.6×83.5 (in)
PRODUCT WEIGHT	223 kg / 492 lbs
40'	68 Sets
WEIGHT STACK	91 kg / 200 lbs

IF1860
1860 HOME GYM

PRODUCT DIMENSION (L×W×H)	2195×1275×2120 (mm) 86.4×50.2×83.5 (in)
PRODUCT WEIGHT	253.7 kg / 559 lbs
40'	60 Sets
WEIGHT STACK	91 kg / 200 lbs



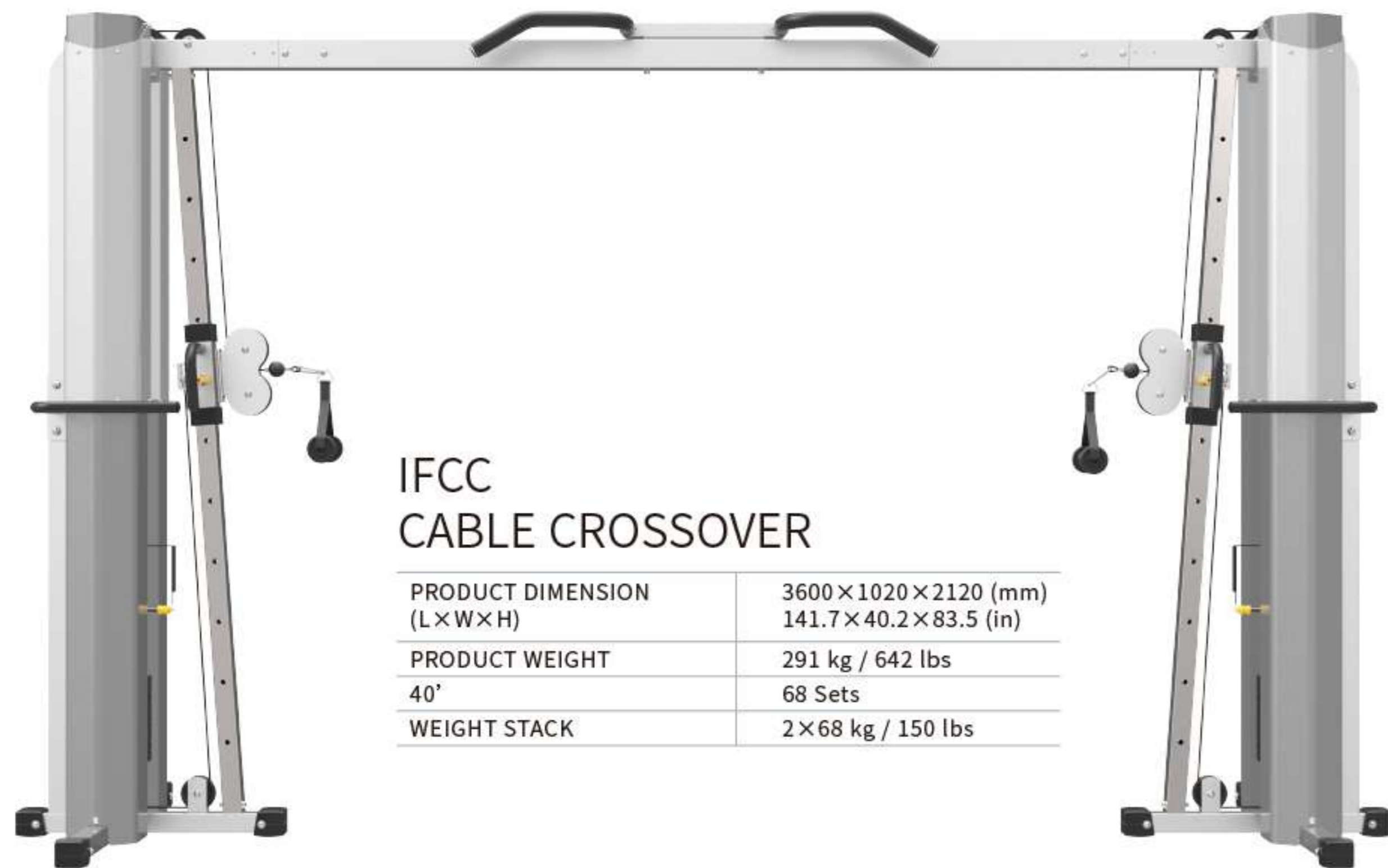

IFCC CABLE CROSSOVER

PRODUCT DIMENSION (L×W×H)	3600×1020×2120 (mm) 141.7×40.2×83.5 (in)
PRODUCT WEIGHT	291 kg / 642 lbs
40'	68 Sets
WEIGHT STACK	2×68 kg / 150 lbs



IFFT FUNCTIONAL TRAINER

PRODUCT DIMENSION (L×W×H)	1662×1102×2122 (mm) 65.4×43.4×83.5 (in)
PRODUCT WEIGHT	336 kg / 741 lbs
40'	56 Sets
WEIGHT STACK	2×91 kg / 200 lbs



IFFTOPT MULTI-SELECT STABILIZER

PRODUCT DIMENSION (L×W×H)	1075×260×1120 (mm) 42.3×10.2×44 (in)
PRODUCT WEIGHT	17.3 kg / 38 lbs IFFT+IFFTOPT

Extra thick 3" Duracraft padding covered in sweat and tear resistant Duraguard vinyl

700 lbs weight capacity adjustable FID dumbbell bench

Adjustable back pad coupled with an ergonomically designed 2 position seat

It offers 7 angles from decline to military press positions

A built-in transport wheels for quick storage as well as easy in and out under power cages, cable machines, etc

A foot hold down bar provides the most sturdy and effective bench around

IF2011 FID BENCH

PRODUCT DIMENSION	1368×568×510 (mm) 53.9×22.4×20.1 (in)
PRODUCT WEIGHT	30kg/66lbs



HSP professional physical training equipment is a perfect solution of multiple and customized functional training needs. It is designed to improve strength, endurance, speed, power, agility and dynamic balance. It can meet different requirements of professional athletes, sports teams, physical training center and big commercial gyms.

HSP-PRO001 AIR RESISTANCE DUAL-ARM FUNCTIONAL TRAINER



The 5 LED windows design can accurately display the resistance level, training times(2 windows), peak power percentage and parameters, which is convenient for the user to always grasp the training information to scientifically arrange the training plan



Depending on the height and movement of the trainer, the training arm can be adjusted in coronal plane (up and down) of 180° and at 13 gears. Unilateral horizontal level of both arms (front and rear) 90°, 7 gears adjustment, which is suitable for all heights and training types

Model	HSP-PRO001
Power	110V-220V
Resistance Range	2kg-25kg
Resistance Increment	0.1kg
Product Dimension	2500×1100×2400 (mm) 98.4×43.3×94.5 (in)
Net Weight	150kg/330.7lbs
Fixed	Can be fixed to the floor or wall



Equipped with double training arms, the cable joint end can rotate 360° with the change of force direction of the trainer, ensuring the comfort of the strength exertion and variable force direction need during the training process. Meanwhile, it can protect the cable and extend its service life



It can also expand a variety of accessories to cooperate with various special functional trainings, such as dual pull handle, ankle strap, training bat, training belt, thigh strap, tricep training rope, etc



Through easy-to-understand training guidelines, users can quickly master the training methods of major muscle groups

HSP-PRO002 AIR RESISTANCE FUNCTIONAL TRAINER



Accurate and convenient adjustment: it can adjust resistance at a minimum increment of 0.1kg with two buttons; giving user a better control over the functional training process



Through easy-to-understand training guidelines, users can quickly master the training methods of major muscle groups



Multiple HSP-PRO002 equipment can be designed as a training area to meet the needs of multi-functional training for single trainer or multi-group training



The 50mm-2000mm single pulley track with 36 gears adjustment, and the angle of the pulley can be rotated with the change of the direction of the force, which meets all heights and training types of use, but also to protect the equipment and cable, extend the life of the role

Model	HSP-PRO002
Power	110V-220V
Resistance Range	2kg-37.5kg
Resistance Increment	0.1kg
Resistance Levels	36
Product Dimension	560×445×2340 (mm) 22.0×17.5×92.1 (in)
Net Weight	150kg/330.7lbs
Fixed	Can be fixed to the floor or wall

RE-LIFE

Hydraulic Strength Training Equipment



RL Line >> >

In the face of such a busy pace of life, Impulse timely put forward the concept of 'light fitness', and explored how to exercise to 'win more with less effort', integrate exercise into your daily life and make it a wonderful enjoyment. Unlike conventional strength equipment, 'light fitness tends to listen to the voice of the heart.'

Impulse RE-LIFE light fitness series is tailored for the urban white-collars and young women who love sports, as well as small studios and community gyms. Impulse named the series after RE-LIFE implying that customers can regain the vitality of the body and rebuild the quality of life by using this series of products.

The RE-LIFE series complements any traditional fitness scenario, suitable for users from almost all ages and fitness levels.

8+X Flexible combinations, more possibilities

RE-LIFE series consists of 8 sets of hydraulic resistance training equipment which can be used for bidirectional constant speed operation and 1 set of stretching machine. 8 sets of hydraulic resistance training equipment can realize the function of 15 kinds of traditional strength equipment, and the stretching machine is helpful before and after exercise. Alternatively, depending on the user's needs, the stretching machine can be replaced with a BOSU ball for balance training, cardio pedals, or a HIIT SKI&ROW* or ULTRA BIKE*. Users of different ages and physical qualities can find their own training methods through the flexible combination of 8+X.

* SKI&ROW and ULTRA BIKE are products of Impulse.





The dual-position handle design ensures that the user always finds the perfect posture.



The selection of upholstery is soft, comfortable and elastic, making it more skin-friendly during training and reducing wear. The multifunctional holder allows you to take water cup or mobile phone at your fingertips.



Adjustable hydraulic resistance makes adjustment more refined with eye-catching knob design.

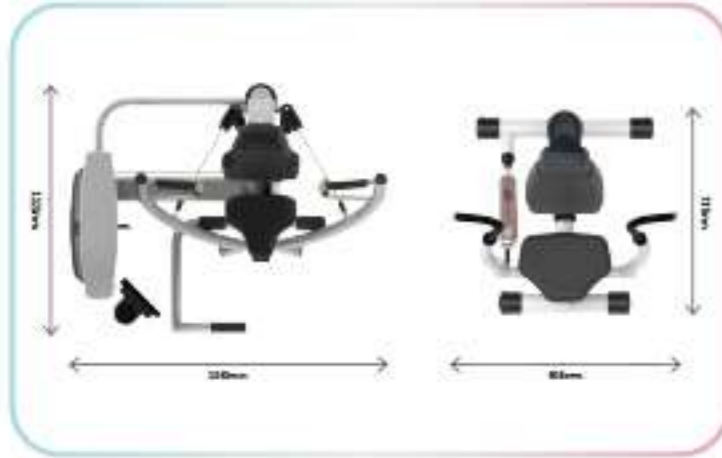

Concise modeling design can save half of the storage and transportation space compared with conventional equipment, the built-in transport wheel design makes it easier to move.



The resistance adapts itself and can stop the movement at any time to reduce the injury risk. In addition, the integrated stable adjusting device can easily adjust the horizontal stability of the product.



Optional painting and upholstery color. (Terms and conditions applied)



RL8101
CHEST PRESS/ROW

PRODUCT DIMENSION (L×W×H)	818×737×1260 (mm) 32.2×29.0×49.6 (in)
PRODUCT WEIGHT	40.4kg/89.1lbs



RL8102
OVERHEAD PRESS/PULLDOWN

PRODUCT DIMENSION (L×W×H)	1120×1000×1296 (mm) 44.1×39.4×50.0 (in)
PRODUCT WEIGHT	45.5kg/100.3lbs



RL8103 BICEPS CURL
TRICEPS EXTENSION

PRODUCT DIMENSION (L×W×H)	1178×736×859 (mm) 46.4×19.0×33.8 (in)
PRODUCT WEIGHT	32.2kg/71lbs



RL8104
PEC FLY/REAR DELTOID

PRODUCT DIMENSION (L×W×H)	1139×895×1286 (mm) 44.8×35.2×50.6 (in)
PRODUCT WEIGHT	48.6kg/107.1lbs



RL8105
LEG EXTENSION/LEG CURL

PRODUCT DIMENSION (L×W×H)	1174×830×1260 (mm) 46.2×32.7×49.6 (in)
PRODUCT WEIGHT	51.8kg/114.2lbs



RL8107
Ab CRUNCH/BACK EXTENSION

PRODUCT DIMENSION (L×W×H)	1097×842×1165 (mm) 43.2×33.1×45.9 (in)
PRODUCT WEIGHT	44.2kg/97.4lbs



RL8108
HIP ABDUCTION/ADDUCTION

PRODUCT DIMENSION (L×W×H)	1122×737×1260 (mm) 44.2×29.0×49.6 (in)
PRODUCT WEIGHT	51.6kg/113.8lbs



RL8110
LEG PRESS

PRODUCT DIMENSION (L×W×H)	1737×737×1260 (mm) 68.4×29.0×49.6 (in)
PRODUCT WEIGHT	71kg/156.5lbs



RL8106
STRETCH

PRODUCT DIMENSION (L×W×H)	1377×755×1237 (mm) 54.2×29.7×48.7 (in)
PRODUCT WEIGHT	37kg/81.6lbs

Mega Space Line >>>

Mega Space products are a specialist, more functional and customized rack strength product solution for strength and conditioning venues. The products can meet the needs of competitive training centers, large commercial clubs and professional studios for professional olympic strength training equipment.

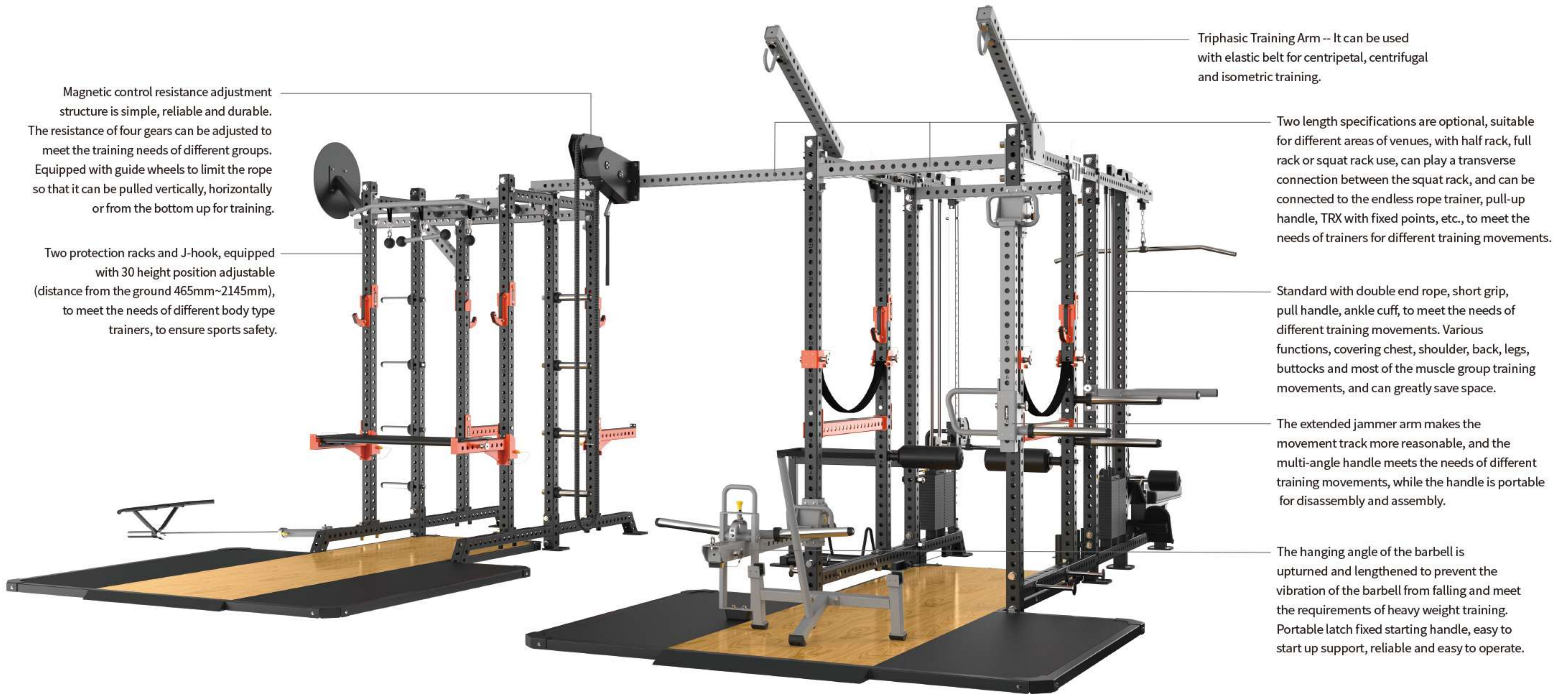

Magnetic control resistance adjustment structure is simple, reliable and durable. The resistance of four gears can be adjusted to meet the training needs of different groups. Equipped with guide wheels to limit the rope so that it can be pulled vertically, horizontally or from the bottom up for training.

Two protection racks and J-hook, equipped with 30 height position adjustable (distance from the ground 465mm~2145mm), to meet the needs of different body type trainers, to ensure sports safety.

Triphasic Training Arm -- It can be used with elastic belt for centripetal, centrifugal and isometric training.

Two length specifications are optional, suitable for different areas of venues, with half rack, full rack or squat rack use, can play a transverse connection between the squat rack, and can be connected to the endless rope trainer, pull-up handle, TRX with fixed points, etc., to meet the needs of trainers for different training movements.

Standard with double end rope, short grip, pull handle, ankle cuff, to meet the needs of different training movements. Various functions, covering chest, shoulder, back, legs, buttocks and most of the muscle group training movements, and can greatly save space.

The extended jammer arm makes the movement track more reasonable, and the multi-angle handle meets the needs of different training movements, while the handle is portable for disassembly and assembly.

The hanging angle of the barbell is upturned and lengthened to prevent the vibration of the barbell from falling and meet the requirements of heavy weight training. Portable latch fixed starting handle, easy to start up support, reliable and easy to operate.

	Shape	Package		Shape	Package
01		2×MS00 STAND-SINGLE STORAGE 2×MS11 LAT PULLDOWN/VERTICAL ROW 2×MS12 FUNCTIONAL CABLE PULLEY 1×MS21/22 RACK CONNECTED BRIDGE	12		2×MS00 STAND-SINGLE STORAGE 4×MS01 HALF RACK 1×MS21/22 RACK CONNECTED BRIDGE
02		2×MS00 STAND-SINGLE STORAGE 2×MS01 HALF RACK 2×MS11 LAT PULLDOWN/VERTICAL ROW 2×MS12 FUNCTIONAL CABLE PULLEY 1×MS21/22 RACK CONNECTED BRIDGE	13		2×MS00 STAND-SINGLE STORAGE 4×MS02 POWER RACK 1×MS21/22 RACK CONNECTED BRIDGE
03		2×MS00 STAND-SINGLE STORAGE 2×MS02 POWER RACK 2×MS11 LAT PULLDOWN/VERTICAL ROW 2×MS12 FUNCTIONAL CABLE PULLEY 1×MS21/22 RACK CONNECTED BRIDGE	14		2×MS00 STAND-SINGLE STORAGE 4×MS01 HALF RACK MS23 BUMPER PLATE STORAGE CONNECTOR BETWEEN RACK MS24 KETTLEBELL STORAGE CONNECTOR BETWEEN RACK MS25 BALL STORAGE CONNECTOR BETWEEN RACK MS26 DUMBBELL STORAGE CONNECTOR BETWEEN RACK
04		1×MS00 STAND-SINGLE STORAGE 1×MS01 HALF RACK			
05		1×MS00 STAND-SINGLE STORAGE 1×MS02 POWER RACK	15		2×MS00 STAND-SINGLE STORAGE 4×MS02 POWER RACK MS23 BUMPER PLATE STORAGE CONNECTOR BETWEEN RACK MS24 KETTLEBELL STORAGE CONNECTOR BETWEEN RACK MS25 BALL STORAGE CONNECTOR BETWEEN RACK MS26 DUMBBELL STORAGE CONNECTOR BETWEEN RACK
06		2×MS00 STAND-SINGLE STORAGE 2×MS01 HALF RACK 1×MS21/22 RACK CONNECTED BRIDGE			
		2×MS00 STAND-SINGLE STORAGE 2×MS01 HALF RACK MS23 BUMPER PLATE STORAGE CONNECTOR BETWEEN RACK MS24 KETTLEBELL STORAGE CONNECTOR BETWEEN RACK MS25 BALL STORAGE CONNECTOR BETWEEN RACK MS26 DUMBBELL STORAGE CONNECTOR BETWEEN RACK	16		2×MS00 STAND-SINGLE STORAGE 4×MS02 POWER RACK 2×MS11 LAT PULLDOWN/VERTICAL ROW 1×MS22 RACK CONNECTED BRIDGE
		2×MS00 STAND-SINGLE STORAGE 2×MS02 POWER RACK 1×MS21/22 RACK CONNECTED BRIDGE	17		2×MS11 LAT PULLDOWN/VERTICAL ROW 2×MS12 FUNCTIONAL CABLE PULLEY 1×MS29 CENTRAL CONNECTED STAND
09		2×MS00 STAND-SINGLE STORAGE 2×MS02 POWER RACK MS23 BUMPER PLATE STORAGE CONNECTOR BETWEEN RACK MS24 KETTLEBELL STORAGE CONNECTOR BETWEEN RACK MS25 BALL STORAGE CONNECTOR BETWEEN RACK MS26 DUMBBELL STORAGE CONNECTOR BETWEEN RACK	18		2×MS11 LAT PULLDOWN/VERTICAL ROW 4×MS12 FUNCTIONAL CABLE PULLEY 1×MS28 MULTI STATION CONNECTED BRIDGE 2×MS29 CENTRAL CONNECTED STAND 2×HSPCF28 MULTI ANGLE PULL UP HANDLE
		1×MS00 STAND-SINGLE STORAGE 2×MS01 HALF RACK	19		4×MS11 LAT PULLDOWN/VERTICAL ROW 4×MS12 FUNCTIONAL CABLE PULLEY 1×MS28 MULTI STATION CONNECTED BRIDGE 2×MS29 CENTRAL CONNECTED STAND 2×HSPCF28 MULTI ANGLE PULL UP HANDLE
11		1×MS00 STAND-SINGLE STORAGE 2×MS02 POWER RACK			

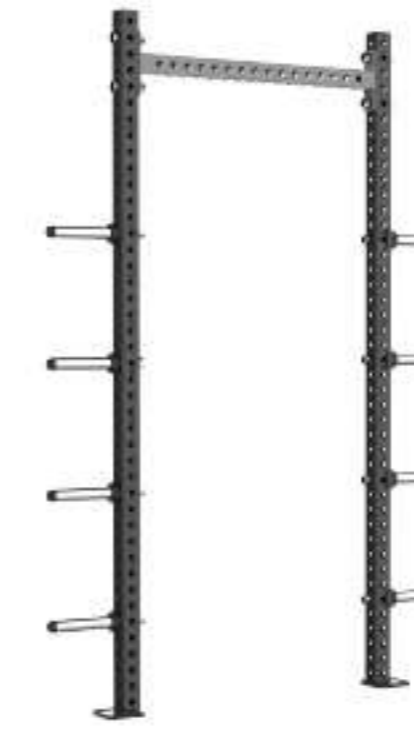

MS00 STAND-SINGLE STORAGE

PRODUCT DIMENSION (L×W×H)	1790×609×2614 (mm) 70.5×24.0×103.0 (in)
PRODUCT WEIGHT	83.4kg/183.9lbs



MS01 HALF RACK

PRODUCT DIMENSION (L×W×H)	1377×1261×2614 (mm) 54.2×49.6×103.0 (in)
PRODUCT WEIGHT	98.3kg/216.7lbs



MS02 POWER RACK

PRODUCT DIMENSION (L×W×H)	1377×2306×2614 (mm) 54.2×90.8×103.0 (in)
PRODUCT WEIGHT	173kg/381.4lbs



MS11 LAT PULLDOWN/VERTICAL ROW

PRODUCT DIMENSION (L×W×H)	1226×2160×2596 (mm) 48.3×85.0×102.2 (in)
PRODUCT WEIGHT	101.7kg/224.2lbs
WEIGHT STACK	295lbs



MS12 FUNCTIONAL CABLE PULLEY

PRODUCT DIMENSION (L×W×H)	496×1313×2599 (mm) 19.5×51.7×102.3 (in)
PRODUCT WEIGHT	51.7kg/114.0lbs
WEIGHT STACK	295lbs



MS15 ENDLESS ROPE TRAINER

PRODUCT DIMENSION (L×W×H)	527×266×537 (mm) 20.7×10.5×21.1 (in)
PRODUCT WEIGHT	32.9kg/72.5lbs



MS13 JAMMER ARM

L.W.H	1395×875×369 (mm) 54.9×34.4×14.5 (in)
N.W	51kg/112.4lbs



MS14 BELT SQUAT

L.W.H	1112×550×677 (mm) 43.8×21.7×26.7 (in)
N.W	21.8kg/48.1lbs



MS21 RACK CONNECTED BRIDGE

L.W.H	240×2056×192 (mm) 9.4×80.9×7.6 (in)
N.W	17.3kg/38.1lbs



MS22 RACK CONNECTED BRIDGE

L.W.H	240×2756×192 (mm) 9.4×108.5×7.6 (in)
N.W	21.4kg/47.2lbs



MS28 MULTI STATION CONNECTED BRIDGE

L.W.H	145×3000×76.2 (mm) 5.7×118.1×3 (in)
N.W	28.5kg/62.8lbs



MS23 BUMPER PLATE STORAGE CONNECTOR BETWEEN RACK)

L.W.H	385×2120×286 (mm) 15.2×83.5×11.3 (in)
N.W	20.1kg/44.3lbs



MS24 KETTLEBELL STORAGE CONNECTOR BETWEEN RACK

L.W.H	441×2120×107 (mm) 17.4×83.5×4.2 (in)
N.W	37.5kg/82.7lbs



MS25 BALL STORAGE CONNECTOR BETWEEN RACK

L.W.H	2120×385×108 (mm) 83.5×15.2×4.3 (in)
N.W	15kg/33.1lbs



MS26 DUMBBELL STORAGE CONNECTOR BETWEEN RACK

L.W.H	2120×385×108 (mm) 83.5×15.2×4.3 (in)
N.W	24kg/52.9lbs



MS27 SIDE STORAGE

L.W.H	995×416×763 (mm) 39.2×16.4×30.0 (in)
N.W	30.8kg/67.9lbs



MS50 LOGO

L.W.H	325×101×50 (mm) 12.8×4.0×2.0 (in)
-------	--------------------------------------



MS7041 BARBELL LIFTER

L.W.H	781×618×905 (mm) 30.7×24.3×35.6 (in)
N.W	11.2kg/24.7lbs



MS7042 FARMER'S WALK BAR

L.W.H	1440×169×76 (mm) 56.7×6.7×3.0 (in)
N.W	15.2kg/33.5lbs



MS7043 T-BAR ROW HANDLE

L.W.H	908×257×205 (mm) 35.7×10.1×8.1 (in)
N.W	4.4kg/9.7lbs



MS7048 POWER SLED

L.W.H	1040×702×922 (mm) 40.9×27.6×36.3 (in)
N.W	27.9kg/61.5lbs



IZCFA16 HEAVY BAG HANGER

L.W.H	963×76.2×600 (mm) 37.9×3.0×23.6 (7in)
N.W	12.8kg/28.2lbs



IZCFA12 WALL BALL TARGET

L.W.H	550×245.7×608 (mm) 21.7×9.7×23.9 (in)
N.W	17.6kg/38.8lbs



HSPCF28 MULTI ANGLE PULL UP HANDLE

L.W.H	1143×324×109 (mm) 45×12.8×4.3 (in)
N.W	12.8kg/28.2lbs



HSPCF29 TRIPHASIC TRAINING ARM

L.W.H	1081×721×105 (mm) 42.6×28.4×4.1 (in)
N.W	32kg/70.5lbs

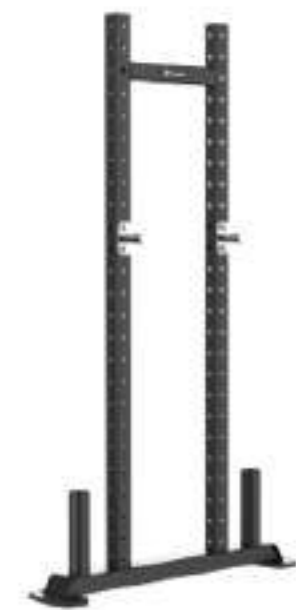

MS704001 STORAGE RACK FRAM

L.W.H	1559×865×210 (mm) 61.4×34.1×8.3 (in)
N.W	20.2kg/44.5lbs



MS704002 BUMPER PLATE STORAGE

L.W.H	2023×385×347 (mm) 79.6×15.2×13.6 (7in)
N.W	20kg/44.1lbs



MS704003 KETTLEBELL STORAGE

L.W.H	2023×441×108 (mm) 79.6×17.4×4.3 (in)
N.W	36.8kg/81.1lbs



MS704004 BALL STORAGE

L.W.H	2023×385×108 (mm) 79.6×15.2×4.3 (in)
N.W	14.9kg/32.8lbs



MS704005 DUMBBELL STORAGE

L.W.H	2023×385×108 (mm) 79.6×15.2×4.3 (in)
N.W	25kg/55.1lbs



HSPCF42 TRICEP DIP ATTACHMENT

L.W.H	649×728×167 (mm) 25.6×28.7×6.6 (in)
N.W	10.1kg/22.3lbs



HSPCF47 RESISTANT BAND ANCHOR

L.W.H	305 (mm) 12.0 (in)
N.W	6.2kg/13.7lbs



HSPCF49 SAFETY STRAPS

L.W.H	1150×50×10 (mm) 45.3×2.0×0.4 (in)
N.W	10.1kg/22.3lbs



HSPCF51 BATTLE ROPE ANCHOR

L.W.H	70×152×180 (mm) 2.8×6.0×7.1 (in)
N.W	2.1kg/4.6lbs



HSPCF52 LANDMINE RACK ATTACHMENT

L.W.H	126×530×240 (mm) 5.0×20.9×9.4 (in)
N.W	8kg/17.6lbs



MS29 CENTRAL CONNECTED STAND

L.W.H	2614×160×160 (mm) 102.9×6.3×6.3 (in)
N.W	17.1kg/37.7lbs



MS41 ADJUSTABLE UTILITY PLATFORM

L.W.H	1340×400×77 (mm) 52.8×15.7×3.0 (in)
N.W	20kg/44.1lbs



MS43 ADJUSTABLE UTILITY PIN

L.W.H	590 (mm) 23.2 (in)
N.W	6.8kg/15lbs



MS44 BARBELL/ UTILITY PLATFORM STORAGE ATTACHMENT

L.W.H	280×240×180 (mm) 11.0×9.4×4.3 (in)
N.W	6kg/13.2lbs



MS45 FOAM ROLLER PAD

L.W.H	559 (mm) 22.0 (in)
N.W	7.3kg/16.1lbs



HSPCF54 J HOOK ATTACHMENT

L.W.H	296×224×224 (mm) 11.7×8.8×8.8 (in)
N.W	6.8kg/15.0lbs



HSPCF59 BALL GRIP ATTACHMENT

L.W.H	321/207/443×209×76 (mm) 12.6/8.1/17.4×8.2×3.0 (in)
N.W	7.8kg/17.2lbs



MS31/SE5031 PLATFORMS

L.W.H	2446×3421×50 (mm) 96.3×134.7×2.0 (in)
N.W	263.5kg/580.9lbs



MS32/HSPCF35 PLATFORMS

L.W.H	2576×3825×54 (mm) 101.4×150.6×2.1 (in)
N.W	280kg/617.3lbs

FF Line >>>

Discover the perfect fusion of functionality and storage! We proudly present our latest product, a revolutionary combination of functional training and storage rack functionality. Welcome to experience this innovative product that will bring endless possibilities to your fitness space!

FF stands out with its unique design and multifunctionality. It not only offers an efficient area for functional training but also cleverly incorporates storage rack capabilities. By connecting extension module, you can extend it endlessly to the right, creating a spacious storage rack and an infinite functional training area.

Thoughtful design: The product is made with high-quality materials and exquisite craftsmanship. The vertical columns and crossbeams are constructed using 3mm thick tubes to ensure sturdiness and durability, meeting the high-intensity demands of commercial environments.

Multi-functionality: The versatile FF series offers not only a variety of configurations for different types of functional training to help you achieve diverse fitness goals, but also seamlessly integrates storage functionality into the product. With multiple storage compartments, it ensures your workout area remains neat and organized, maximizing space utilization at all times.

The storage shelf can be installed at a 27-degree angle, adding both aesthetic appeal and convenient access to various accessories.

The **Center-based** design concept involves anchoring in the middle of the space, requiring only a connection to the floor. This maximizes the position for suspended multi-functional training and accommodates more individuals for training.

Flexible extension: With the ability to connect the Extension Module, you can effortlessly extend the product to the right, creating storage racks and functional training areas of various sizes based on your space requirements.

Comes with multiple hooks designed for the use and storage of resistance bands and other training straps, allowing you to adjust their positions according to your preferences for added convenience.

The spacing between the main upright holes is 100mm. You can adjust the positions and heights of storage shelves, hooks, and other accessories according to your specific usage scenarios.

The **Wall-based** design concept aims to maximize space utilization by requiring connections to both the wall and the floor. This provides additional storage space while also offering the potential for more multi-functional training opportunities.

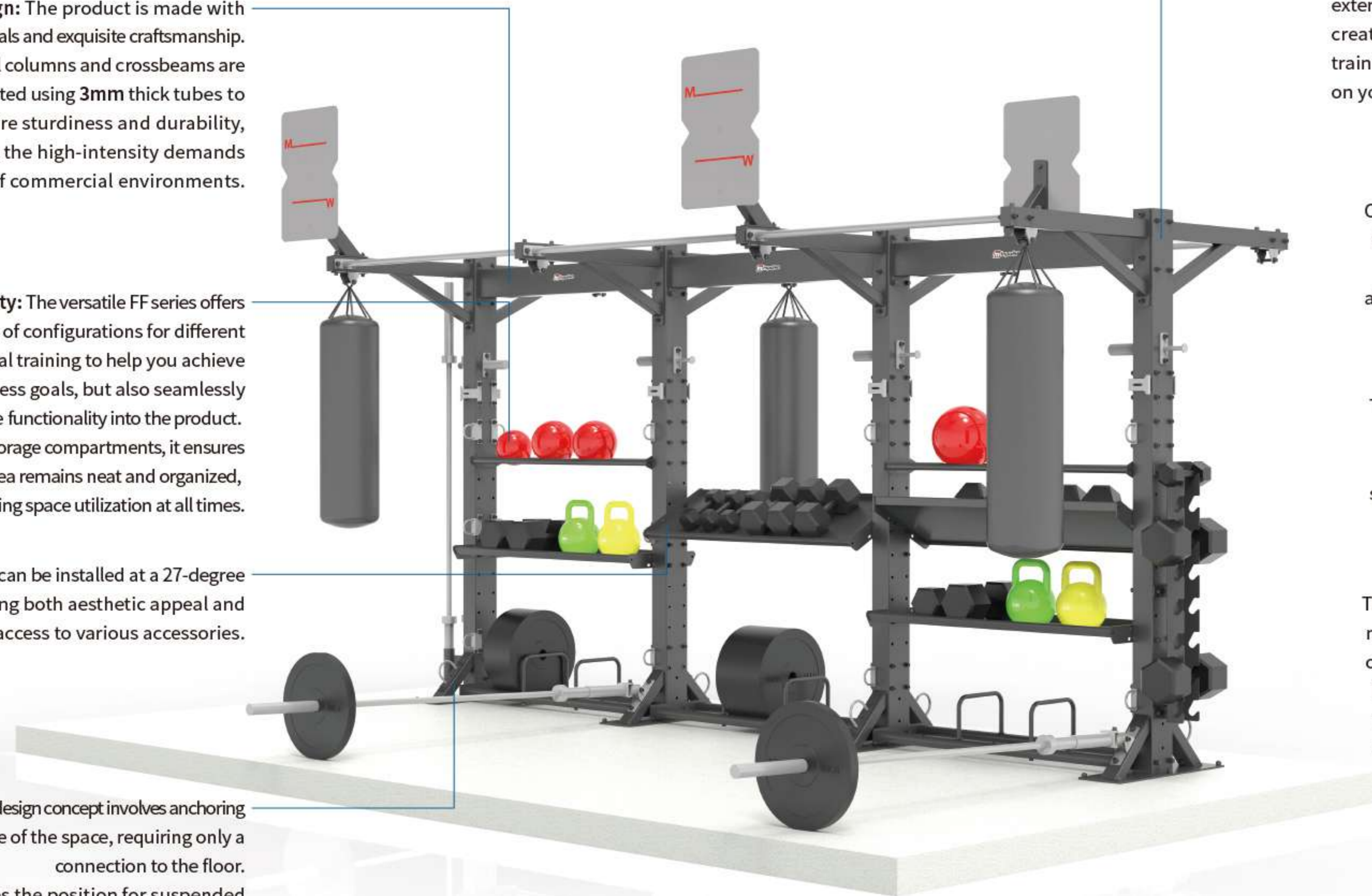

*All accessories shown in the image, such as dumbbells, kettlebells, medicine balls, barbells, sandbags, resistance bands, etc., are for demonstration purposes only. The actual product does not come with such accessories.

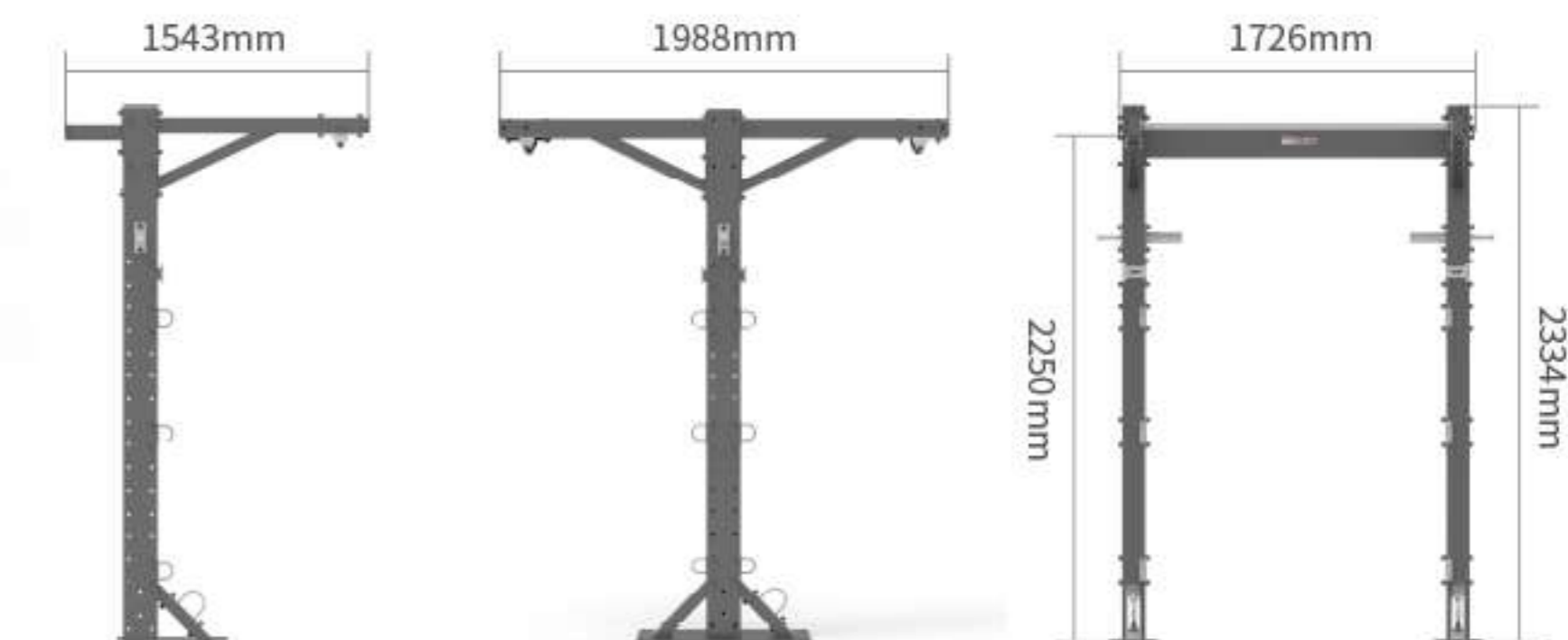
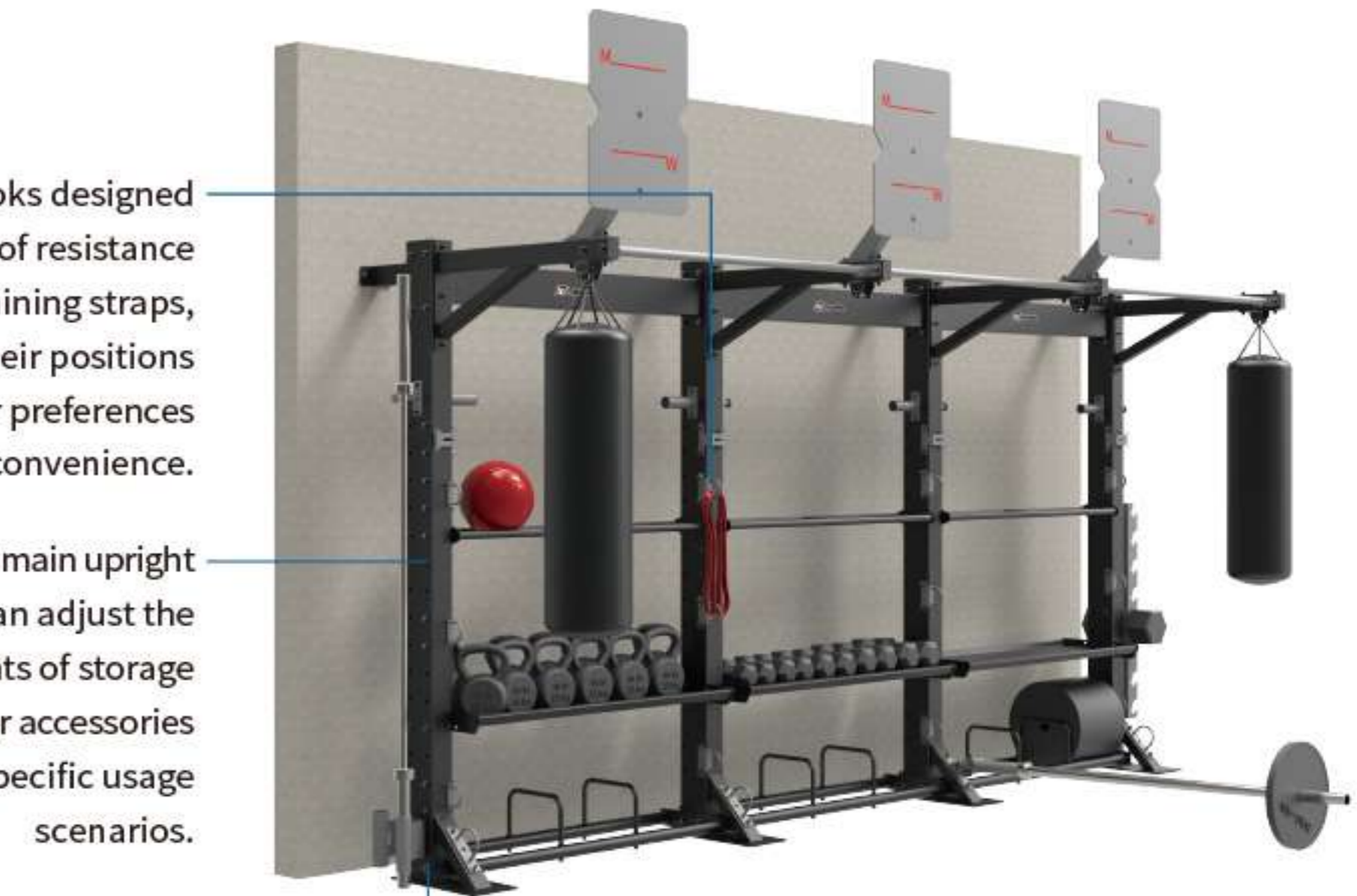



FF00 MAIN RACK (WALL-BASED)



FF1011 EXPANSION MODULE (WALL-BASED)



FF00+FF1011



FF01 MAIN RACK (CENTER-BASED)



FF1012 EXPANSION MODULE (CENTER-BASED)



FF01+FF1012



FF02 BACK RACK



FF02+FF1013+FF00+FF1011+3*FF24+FF25+FF44+FF46+FF52+FF53



FF1013 BACK RACK EXTENSION

Shape	Package/Product Dimension
	1× FF00 FF1011 FF23 FF24 FF25 FF44 FF46 FF52 FF53 1726×1321×2334(mm) 68.0×52.0×91.9(in)
	1× FF00 2× FF1011 FF23 FF24 FF25 FF44 FF46 FF52 FF53 3269×1321×2334(mm) 128.7×52.0×91.9(in)
	1× FF00 3× FF1011 FF23 FF24 FF25 FF44 FF46 FF52 FF53 4812×1321×2334(mm) 189.4×52.0×91.9(in)
	1× FF01 FF1012 FF23 FF24 FF25 FF44 FF46 FF52 FF53 1726×1988×2334(mm) 68.0×78.7×91.9(in)
	1× FF01 FF23 2× FF1012 FF24 FF25 FF44 FF46 FF52 FF53 3269×1988×2334(mm) 128.7×78.7×91.9(in)
	1× FF01 3× FF1012 4812×1988×2334(mm) 189.4×78.7×91.9(in)



FF00 MAIN RACK (WALL-BASED)

L.W.H	367×1321×2334 (mm) 14.4×52.0×91.9 (in)
N.W	51.6kg/113.7lbs



FF01 MAIN RACK (CENTER-BASED)

L.W.H	367×1998×2334 (mm) 14.4×78.7×91.9 (in)
N.W	67kg/147.7lbs



FF02 BACK RACK

L.W.H	285×300×2380 (mm) 11.2×11.8×93.7 (in)
N.W	43.5kg/95.9lbs



FF1011 EXPANSION MODULE (WALL-BASED)

L.W.H	1641×1321×2334 (mm) 64.6×52.0×91.9 (in)
N.W	73.3kg/161.6lbs



FF1012 EXPANSION MODULE (CENTER-BASED)

L.W.H	1641×1988×2334 (mm) 64.6×78.7×91.9 (in)
N.W	93kg/205lbs



FF1013 BACK RACK EXTENSION

L.W.H	345×270×2380 (mm) 13.6×10.6×93.7 (in)
N.W	62.5kg/137.8lbs



FF-SP STORAGE POST

L.W.H	2338×675×1016 (mm) 92.0×26.6×91.9 (in)
N.W	190kg/418.9lbs



FF23 TRAINING PLATE STORAGE

L.W.H	1555×370×251 (mm) 61.2×14.6×9.9 (in)
N.W	12.1kg/26.7lbs



FF24 DUMBBELL KETTLEBELL STORAGE

L.W.H	1555×465×74 (mm) 61.2×18.3×2.9 (in)
N.W	20.6kg/45.4lbs



FF25 BALL STORAGE

L.W.H	1555×230×70 (mm) 61.2×9.1×2.8 (in)
N.W	7.1kg/15.7lbs



FF44 BARBELL STORAGE

L.W.H	236×194×200 (mm) 10.4×7.6×7.9 (in)
N.W	3.6kg/7.9lbs

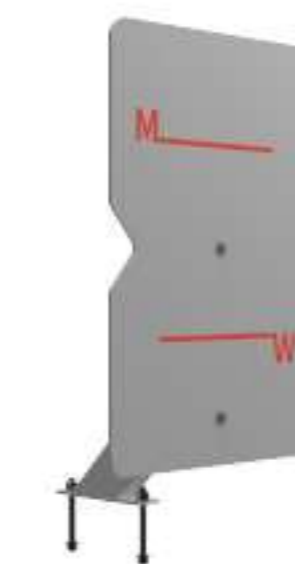

FF46 WALL BALL TARGET

L.W.H	450×355×821 (mm) 17.7×14.0×32.3 (in)
N.W	16kg/35.3lbs



FF52 LANDMINE RACK ATTACHMENT

L.W.H	380×200×100 (mm) 15.0×7.9×3.9 (in)
N.W	3.3kg/7.3lbs



FF53 VERTICAL DUMBBELL STORAGE

L.W.H	1070×260×140 (mm) 42.1×10.2×5.5 (in)
N.W	9.8kg/21.6lbs

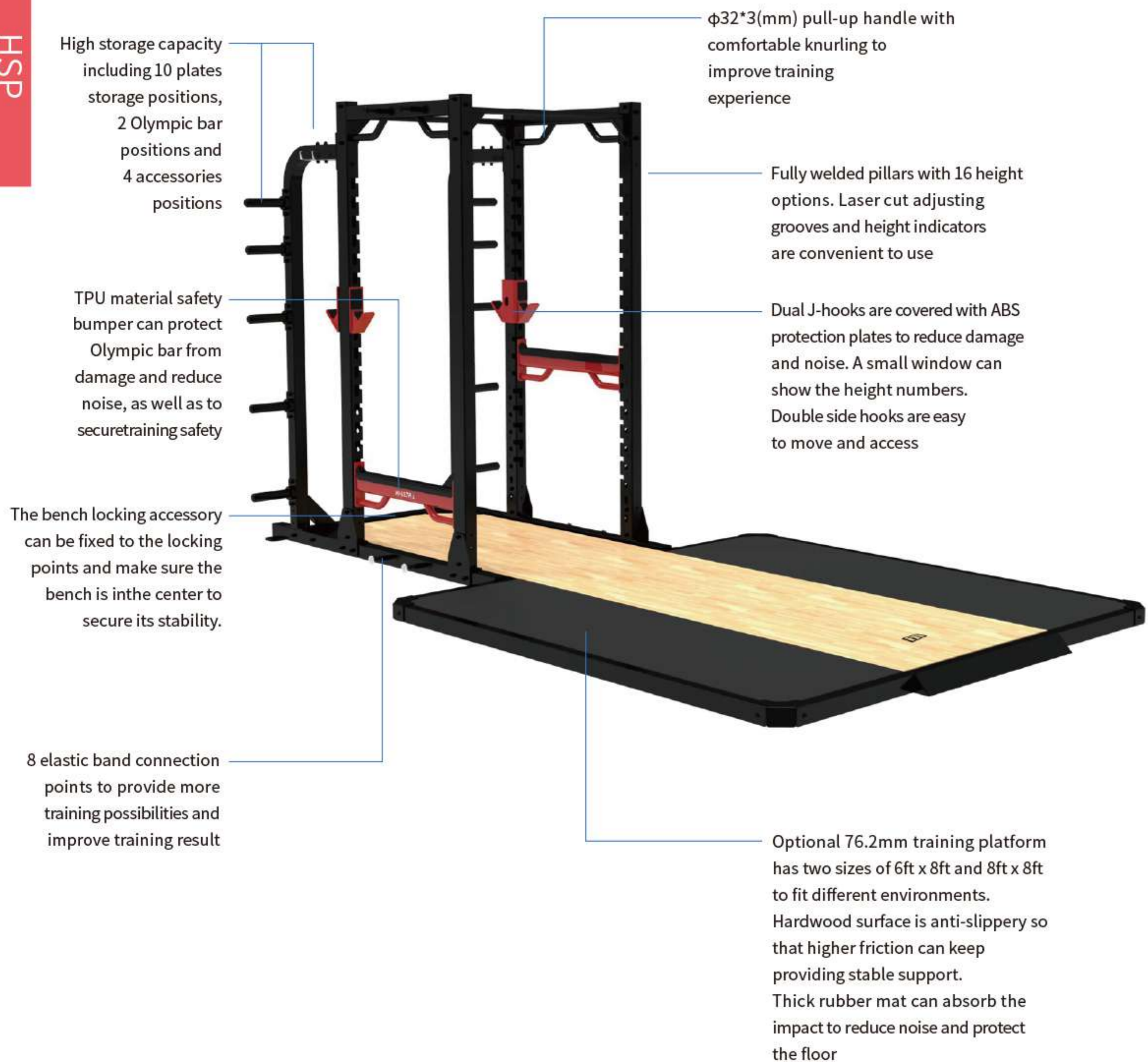

Shape		Optional Accessory Package	Product Dimension
HSPR01-HALF RACK		HSP7011 ADJUSTABLE DOCK' N LOCK BENCH HSPR21 RACK CONNECTOR-MULTI-GRIP HSPR31 PLATFORM(6FT*8FT) HSPR41 STEP ATTACHMENT HSPR42 DIP ATTACHMENT HZ7008 BATTLE ROPE ATTACHMENT IZ7012 PIVOT SE5043 SPOTTER STANDS	1750×1470×2480(mm) 68.9×57.9×97.6(in)
HSPR02-POWER RACK		HSP7011 ADJUSTABLE DOCK' N LOCK BENCH HSPR21 RACK CONNECTOR-MULTI-GRIP HSPR32 PLATFORM(8FT*8FT) HSPR41 STEP ATTACHMENT HSPR42 DIP ATTACHMENT HZ7008 BATTLE ROPE ATTACHMENT IZ7012 PIVOT SE5043 SPOTTER STANDS	2085×1750×2480(mm) 82.1×68.9×97.6(in)
HSPR03-DOUBLE HALF RACK		HSP7011 ADJUSTABLE DOCK' N LOCK BENCH HSPR21 RACK CONNECTOR-MULTI-GRIP HSPR31 PLATFORM(6FT*8FT) HSPR41 STEP ATTACHMENT HSPR42 DIP ATTACHMENT HZ7008 BATTLE ROPE ATTACHMENT IZ7012 PIVOT SE5043 SPOTTER STANDS	2595×1750×2480(mm) 102.2×57.9×97.6(in)



HSPR31 PLATFORM(6FT*8FT)

PRODUCT DIMENSION	3140×2560×76.2 (mm) 123.6×100.8×3.0 (in)
PRODUCT WEIGHT	263.5kg/580.9lbs



HSPR32 PLATFORM(8FT*8FT)

PRODUCT DIMENSION	4355×2560×76.2 (mm) 171.5×100.8×3.0 (in)
PRODUCT WEIGHT	263.5kg/580.9lbs



Group Functional Training Solutions





	Shape	Package	Product Dimension	Optional Accessory Package
IZ-S		IZ7001 Stretching Station IZ7003 Rebounder Station IZ7011 S-joint	3250×1120×2364(mm) 128×44.1×93.1(in)	IZ7009 Step Attachment IZ7010 DIP Attachment IZ7012 Pivot Kettlebell, Battle Rope, TRX, Medicine ball, Bar, Plate etc.
IZ-I		IZ7001 Stretching Station IZ7002 Boxing Station IZ7008 Stair-1	4794×1654×2446(mm) 188.7×65.1×96.3(in)	IZ7009 Step Attachment IZ7010 DIP Attachment IZ7012 Pivot Kettlebell, Punching Bag, Battle Rope, TRX, Medicine ball, Bar, Plate etc.
IZ-L		IZ7001 Stretching Station IZ7002 Boxing Station IZ7003 Rebounder Station IZ7008 Stair-1 IZ7011 S-joint	4794×3250×2446(mm) 188.7×128×96.3(in)	IZ7009 Step Attachment IZ7010 DIP Attachment IZ7012 Pivot Kettlebell, Punching Bag, Battle Rope, TRX, Medicine ball, Bar, Plate etc.
IZ-T		IZ7003 Rebounder Station IZ7004 Power Rack Station IZ7005 DAP Station IZ7006 Connector IZ7007 Stair-2	4694×3139×2446(mm) 184.8×123.6×96.3(in)	IZ7012 Pivot Kettlebell, Battle Rope, TRX, Medicine ball, Bar, Plate etc.
IZ-O		IZ7001 Stretching Station IZ7002 Boxing Station IZ7003 Rebounder Station IZ7005 DAP Station IZ7014 Stair-3	3637×3630×2446(mm) 141.3×136.7×96.3(in)	IZ7009 Step Attachment IZ7010 DIP Attachment IZ7012 Pivot Kettlebell, Punching Bag, Battle Rope, TRX, Medicine ball, Bar, Plate etc.
IZ-H		IZ7001 Stretching Station IZ7002 Boxing Station IZ7003 Rebounder Station IZ7005 DAP Station IZ7015 Stair-4	4137×2880×2449(mm) 162.9×113.4×96.4(in)	IZ7009 Step Attachment IZ7010 DIP Attachment IZ7012 Pivot Kettlebell, Punching Bag, Battle Rope, TRX, Medicine ball, Bar, Plate etc.
IZ-X		IZ7002 Boxing Station IZ7003 Rebounder Station IZ7004 Power Rack Station IZ7005 DAP Station IZ7006 Connector IZ7007 Stair-2×2	7489×3139×2446(mm) 294.8×123.6×96.3(in)	IZ7009 Step Attachment IZ7010 DIP Attachment IZ7012 Pivot Kettlebell, Punching Bag, Battle Rope, TRX, Medicine ball, Bar, Plate etc.



CASES



CASES



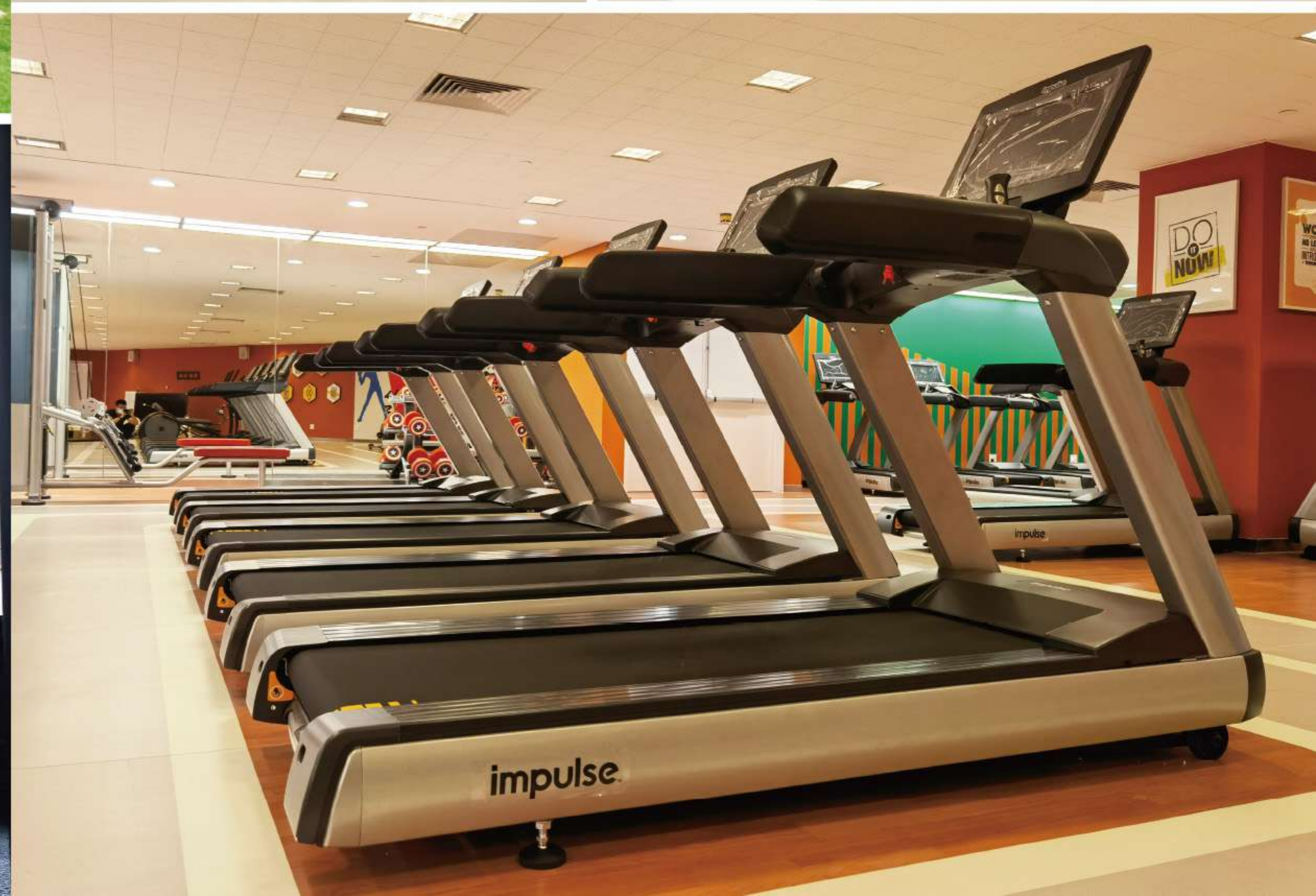
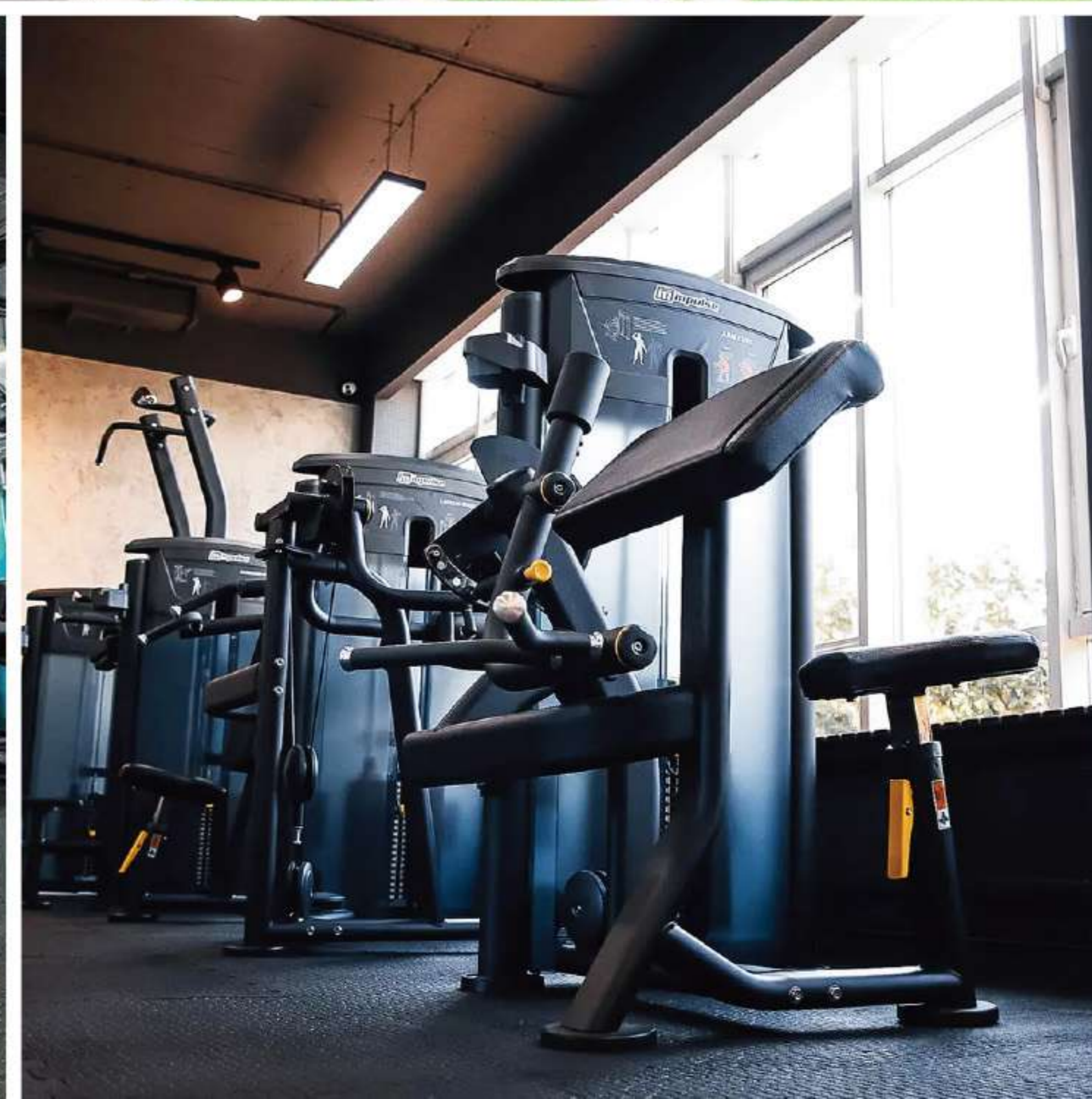



CASES



CASES





Impulse Cardiovascular Equipment Limited Warranty

Description	Warranty
Frame	7 Years
Treadmill AC Motor	3 Years
Treadmill DC Motor, Structural Moving Parts	2 Years
Display PCB, Motor Controller, Generator, EMS, ECB Brake	2 Years
Key Pad, Durable Wear Parts	1 Year

Impulse Strength Training Equipment Limited Warranty

Description	Warranty
Structural Steel Frame	Lifetime
Rotary Bearings, Weight Stacks, Pulleys, Guide Rods, Structural Moving Parts	2 Years
Cable, Linear Bearings, Springs	1 Year
Upholstery, Handgrips, All Other	6 Months
Items Not Listed	6 Months

* Conditions and Restrictions Applied.





im impulse

THE WAY TO WELLNESS



All text, picture and data in this catalogue are for reference only. If there is inconsistency between the information and the actual product, the actual product shall govern. Impulse reserves all rights to explain any error or difference in this catalogue.

The trademark property in copyright including "Siegling", "Wahoo" and "Polar" have been mentioned in Impulse product catalogues belong to their respective trademark registers.

Statement: Impulse branding is upgrading and during that time, **im impulse** and **impulse** are both trademarks of Impulse products. Thank you for your support as always.